



MEDIUM TO LARGE TURNING CENTERS WITH
2-AXIS THROUGH TO Y-AXIS MACHINING CAPABILITIES

PUMA

4100/L/LM/M/XL/XLM •
5100/L/LM/LY/M/XL/XLM/XLY



PUMA 4100 · 5100 SERIES

PUMA 4100/5100 series machines are horizontal turning centers designed for machining medium-to-large size workpieces. They are powerful machines using a two-step gearbox and high torque motors and feature a rigid box guideway structure. Selected models can process complex workpieces by using the optional Y-axis function and, optional DN Solutions threading functions, especially useful for oil and gas parts, make PUMA 4100/5100 machines the ideal solution for many industries and applications.

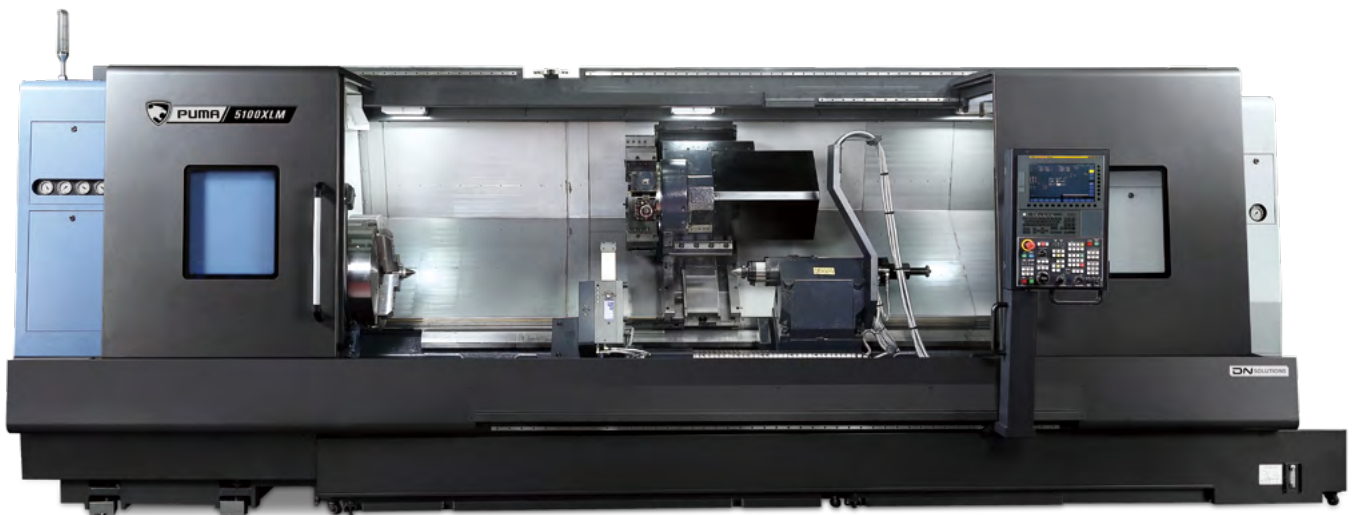



PRODUCT LINE-UP

- For machining a range of different, medium-to-large sized workpieces, there are 38 Puma 4100/5100 models available. The product range comprises turning centers with chuck sizes from 12" to 21" in diameter with optional big bore spindle capability, 1m/2m/3m turning lengths and 2-axis to Y-axis configurations.

POWERFUL MACHINING CAPABILITY

- PUMA 4100/5100 machines have powerful machining capabilities that optimize their cutting performance thanks to their two-speed gearboxes, high-torque spindle motors and stable box guideway structures.

IMPROVED EFFICIENCY

- PUMA 4100/5100 machines can process complex parts in just one set up by applying the optional Y-axis function. In addition, the newly-designed operation panel and optional threading functions optimize efficiency.

BASIC STRUCTURE

Product range is extensive and includes 2-axis models up to Y-axis machines, which enable large, complex parts to be completed in a single set up.

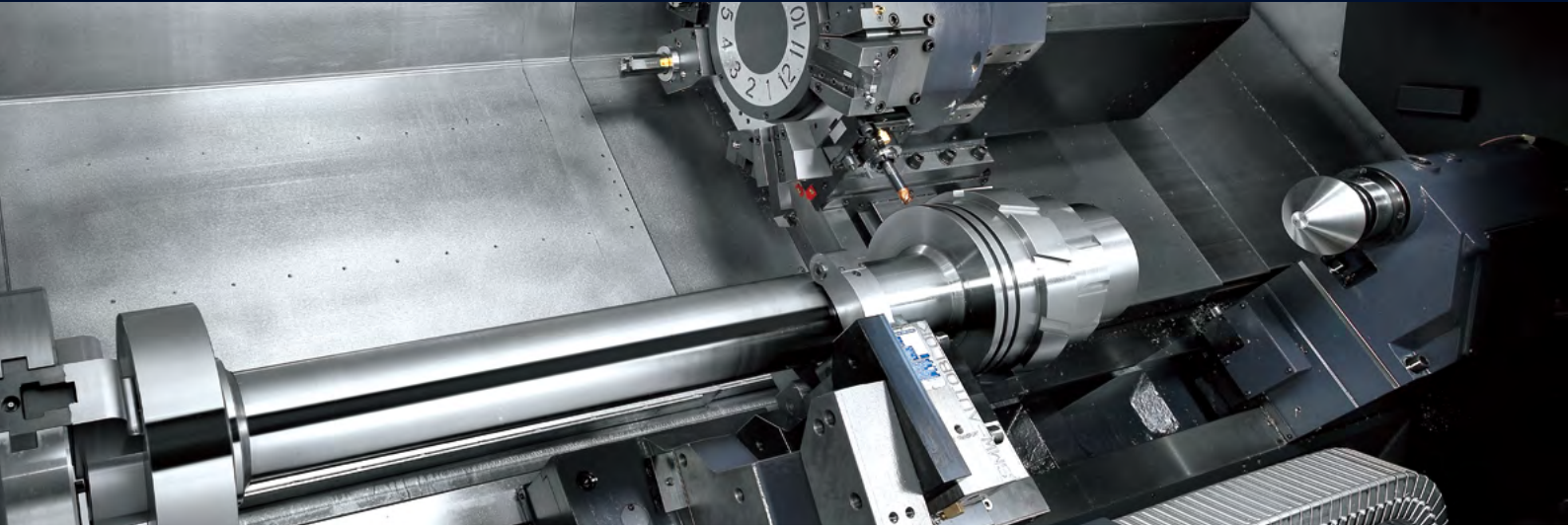

Model	Chuck size (inch)	Standard model (Max. turning length 1m)			L(Long)-model (Max. turning length 2m)			XL(Extra long)-model (Max. turning length 3m)			
		2-axis	M	Y	2-axis	M	Y	2-axis	M	Y	
PUMA 4100 series	A	12	o	o	-	o	o	-	o	o	-
	B	15	o	o	-	o	o	-	o	o	-
	C	21	o	o	-	o	o	-	o	o	-
PUMA 5100 series	A	15	o	o	-	o	o	o	o	o	o
	B	21	o	o	-	o	o	o	o	o	o
	C	Big bore	o	-	-	o	-	o	o	-	-

SPINDLE

The gearbox design gives PUMA 4100/5100 spindles unparalleled power and torque, boosting productivity and process reliability during heavy-duty machining operations.

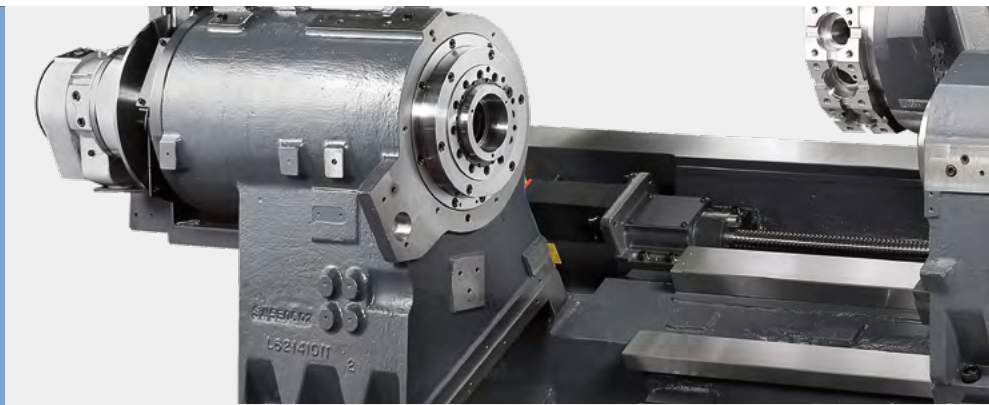

Max. spindle speed

1500 r/min

Max. spindle power (30min/Cont.)

45/37 kW
60.3/49.6 Hp

Max. spindle torque

4038 N·m
2980.0 ft-lb

Model	Max. spindle speed r/min	Max. spindle power (30min/Cont.)kW (Hp)	Max. spindle torque N·m (ft-lb)
PUMA 4100A / LA / XLA	3000	35 (S3 25%)/26/22 (46.9 (S3 25%)/34.9/29.5)	1584 (1169.0)
PUMA 4100B / LB / XLB	2000	35 (S3 25%)/26/22 (46.9 (S3 25%)/34.9/29.5)	2379 (1755.7)
PUMA 4100C / LC / XLC	1500	37/30 (49.6/40.2)	3280 (2420.6)
PUMA 4100MA / LMA / XLMA	3000	30/22 (40.2/29.5)	832 (614.0)
PUMA 4100MB / LMB / XLMB	2000	30/22 (40.2/29.5)	1611 (1188.9)
PUMA 4100MC / LMC / XLMC	1500	37/30 (49.6/40.2)	2432 (1794.8)
PUMA 5100A / LA / XLA	2000	37/30 (49.6/40.2)	3280 (2420.6)
PUMA 5100B / LB / XLB	1500	45/37 (60.3/49.6)	4038 (2980.0)
PUMA 5100C / LC / XLC	1000	45/37 (60.3/49.6)	4463 (3293.7)
PUMA 5100MA / LMA / XLMA	2000	37/30 (49.6/40.2)	2432 (1794.8)
PUMA 5100MB / LMB / XLMB	1500	45/37 (60.3/49.6)	2957 (2182.3)
PUMA 5100LYA / XLYA	2000	37/30 (49.6/40.2)	2431 (1794.1)
PUMA 5100LYB / XLYB	1500	45/37 (60.3/49.6)	2957 (2182.3)
PUMA 5100LYC	1000	45/37 (60.3/49.6)	3268 (2411.8)

MACHINING AREA

The largest working envelopes in their class with maximum turning diameters up to Ø650 mm and maximum turning lengths of 3m.

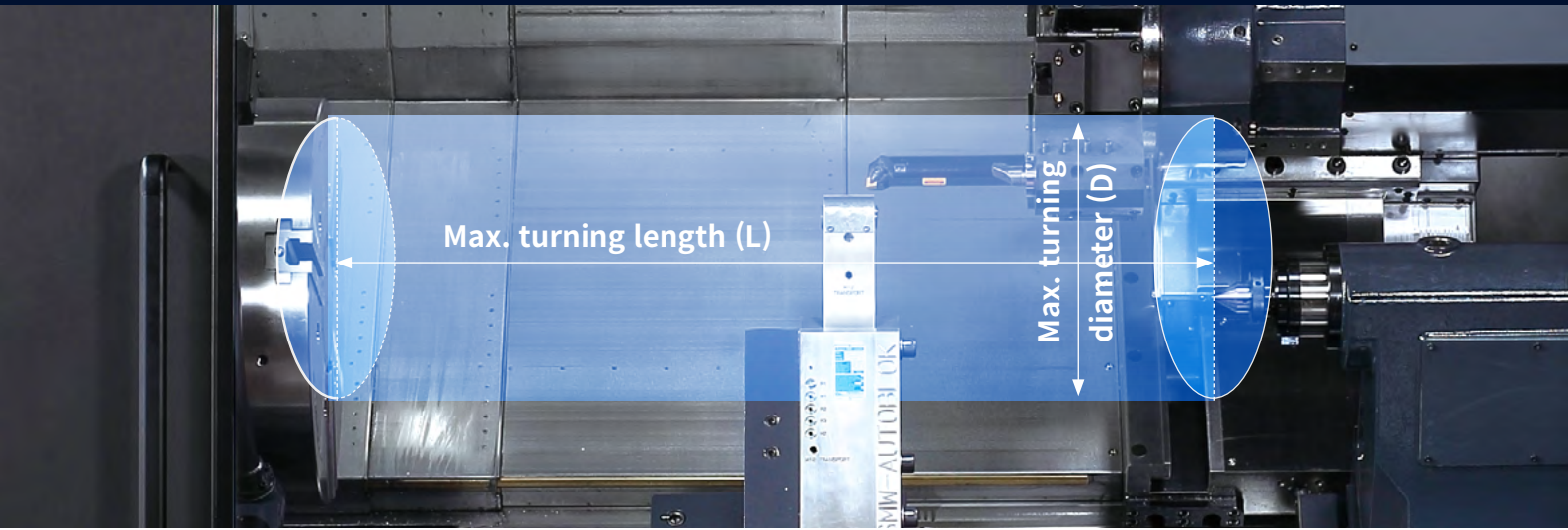

Unit : mm (inch)

Max. turning diameter

Ø650 mm
Ø25.6 inch

Max. turning length

3152 mm
Ø124.1 inch

Function	Model	Max. "D"	Max. "L"
2-axis (for Turning)	PUMA 4100A / LA / XLA	550 (21.7)	1074 / 2124 / 3152 (42.3 / 83.6 / 124.1)
	PUMA 4100B / LB / XLB	550 (21.7)	1042 / 2092 / 3120 (41.0 / 82.4 / 122.8)
	PUMA 4100C / LC / XLC	550 (21.7)	1002 / 2052 / 3080 (39.4 / 80.8 / 121.3)
	PUMA 5100A / LA / XLA	650 (25.6)	1032 / 2082 / 3082 (40.6 / 82.0 / 121.3)
	PUMA 5100B / LB / XLB	650 (25.6)	992 / 2042 / 3042 (39.1 / 80.4 / 119.8)
	PUMA 5100C / LC / XLC	650 (25.6)	992 / 2042 / 3042 (39.1 / 80.4 / 119.8)
M-model (for Turn-Milling)	PUMA 4100MA / LMA / XLMA	560 (22.0)	1010 / 2060 / 3100 (39.8 / 81.1 / 122.0)
	PUMA 4100MB / LMB / XLMB	560 (22.0)	978 / 2028 / 3068 (38.5 / 79.8 / 120.8)
	PUMA 4100MC / LMC / XLMC	560 (22.0)	938 / 1988 / 3028 (36.9 / 78.3 / 119.2)
	PUMA 5100MA / LMA / XLMA	650 (25.6)	992 / 2042 / 3068 (39.1 / 80.4 / 120.8)
	PUMA 5100MB / LMB / XLMB	650 (25.6)	952 / 2002 / 3028 (37.5 / 78.8 / 119.2)
Y-axis model (for Turn-Milling)	PUMA 5100LYA / LYB / LYC	550 (21.7)	2050 / 2020 / 2020 (80.7 / 79.5 / 79.5)
	PUMA 5100LYA / XLYB	550 (21.7)	3070 / 3040 (120.9 / 119.7)

Max. spindle through hole diameter

Ø275 mm
Ø10.8 inch

Machines are available with a range of spindle-through-bore sizes to provide the ideal solution for processing different pipe diameters.

Model		Max. spindle through hole diameter
PUMA 4100	A	115 (4.5)
	B	132 (5.2)
	C	181 (7.1)
PUMA 5100	A	132 (5.2)
	B	181 (7.1)
	C	275 (10.8)

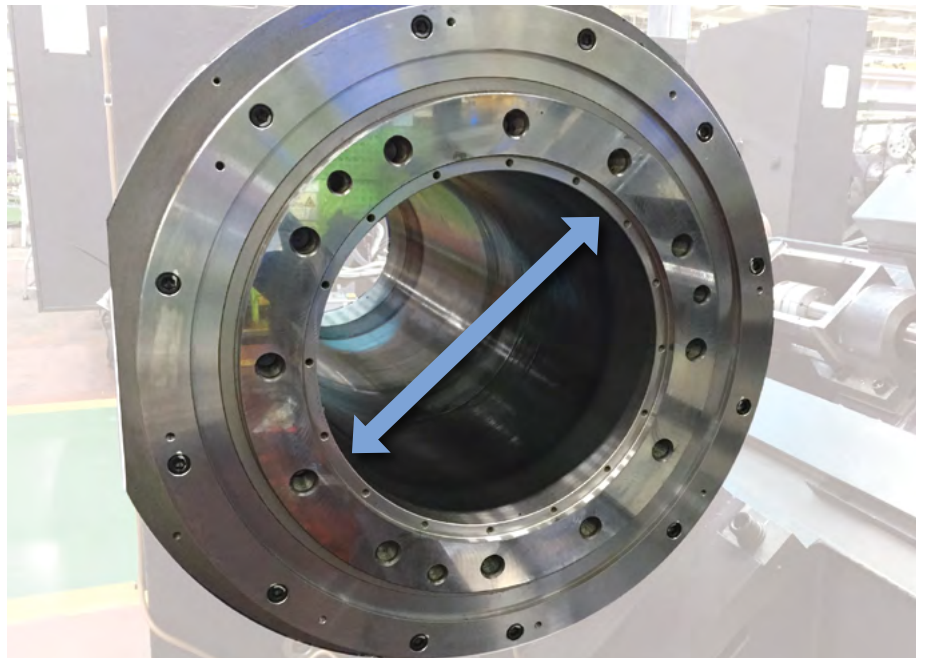

TAILSTOCK

Highly-rigid hydraulic tailstocks are clamped to bed slide-ways to provide stable support when machining long workpieces.

Tailstock travels

1000 / 2050 / 3070 mm
39.4 / 80.7 / 120.9 inch

Model	Tailstock travel	Quill diameter	Quill travel
PUMA4100 / M, PUMA 5100 / M	1000 (39.4)	120 (4.7)	120 (4.7)
PUMA4100L / LM, PUMA 5100L / LM	2050 (80.7)	120 (4.7)	120 (4.7)
PUMA4100XL / XLM, PUMA 5100XL / XLM	3070 (120.9)	120 (4.7)	120 (4.7)
PUMA 5100LY	2050(80.7)	120 (4.7)	120 (4.7)
PUMA 5100XLY	3050 (119.7)	120 (4.7)	120 (4.7)

Model	Std.	Opt.
PUMA4100 / M, PUMA 5100 / M	Manual	Programmable
PUMA4100L / LM, PUMA 5100L / LM		
PUMA4100XL / XLM, PUMA 5100XL / XLM		
PUMA 5100LY	Programmable	-
PUMA 5100XLY		

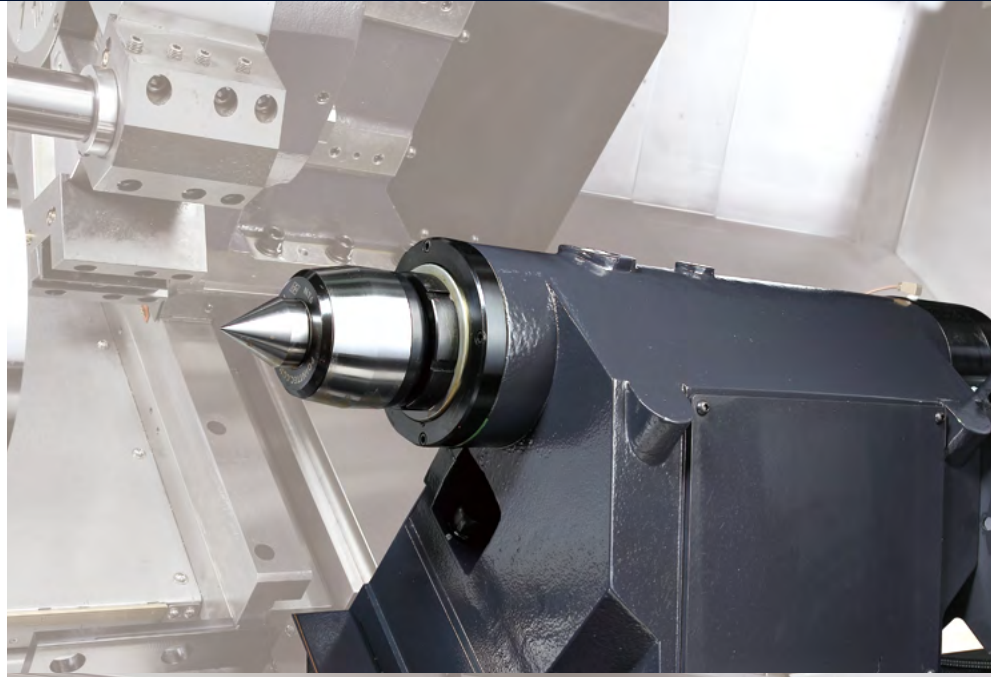

TURRET

Turret rotation is controlled by servo-motors that ensure fast and reliable tool selection. The unique BMT85P turret design is used on M- and Y- models and boost these machines' heavy-duty milling performance.

2-axis model

No. of tool stations

PUMA 4100A / LA / XLA

12 {**10**_{OPTION}} ea

PUMA 4100B / LB / XLB / C / LC / XLC

PUMA 5100 series

10 {**12**_{OPTION}} ea

M,Y MODEL

Tool holder type

BMT75P

No. of tool station

12 {**24**_{OPTION}} ea

Max. rotary tool speed

4000 {**8000**_{OPTION}} r/min

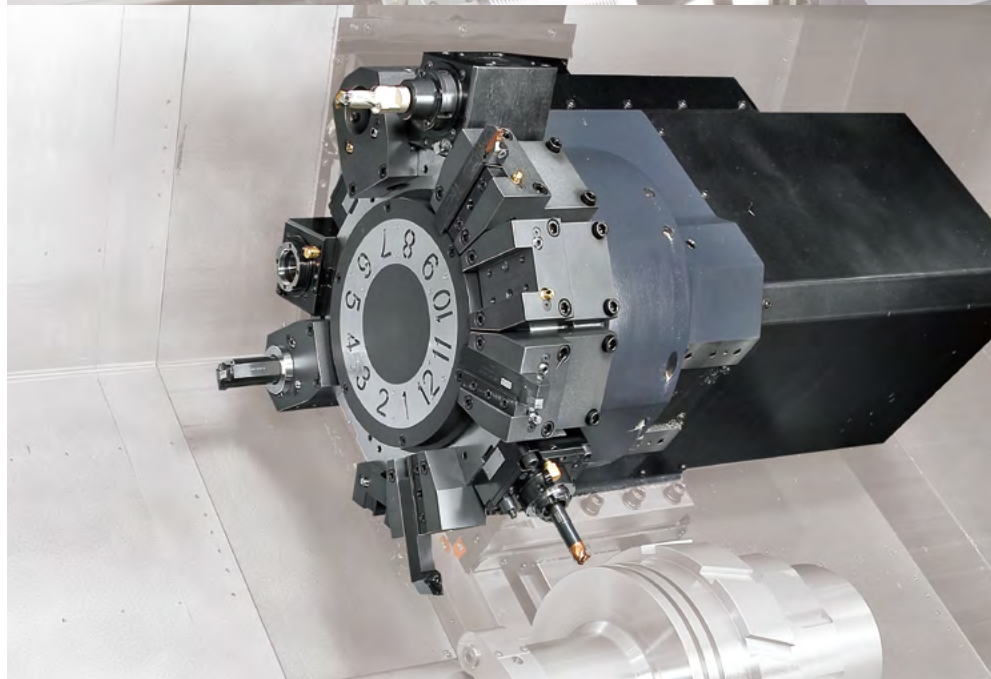
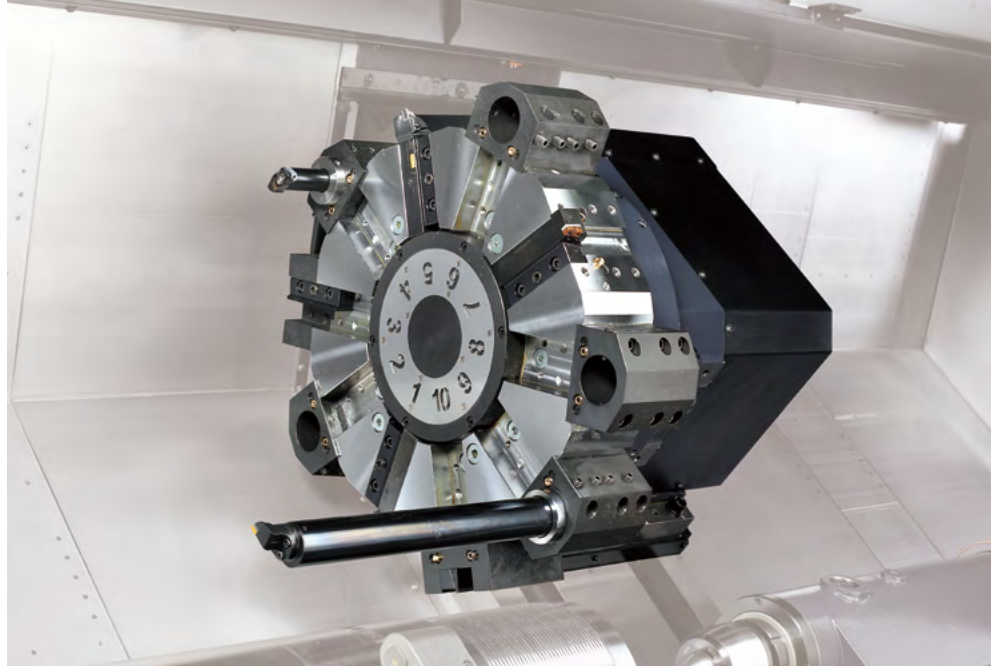

STANDARD | OPTIONAL SPECIFICATIONS

A range of options is available to suit individual requirements.

Description	Features	PUMA 4100 series						PUMA 5100 series							
		A	B	C	MA	MB	MC	A	B	C	MA	MB	LYA/XLYA	LYB/XLYB	LYC
CHUCK	None	○	○	○	○	○	○	○	○	○	○	○	○	○	
	12 Inch	●	X	X	○	X	X	X	X	●	X	X	○	○	
	15 Inch	X	●	X	X	●	X	●	X	X	●	X	●	X	
	18 Inch	X	○	X	X	○	X	○	X	X	○	X	X	X	
	21 Inch	X	X	●	X	X	●	X	●	X	X	●	X	○	X
	24 Inch	X	X	X	X	X	X	X	X	X	X	X	X	○	X
JAW	Special Chuck	△	△	△	△	△	△	△	△	△	△	△	△	△	
	Soft Jaws	●	●	●	●	●	●	●	●	●	●	●	●	○	
CHUCKING OPTION	Hardened & ground hard jaws	○	○	○	○	○	○	○	○	○	○	○	○	○	
	Single pressure chucking	●	●	●	●	●	●	●	●	●	●	●	●	○	
	Dual pressure chucking	○	○	○	○	○	○	○	○	○	○	○	○	○	
TURRET	Chuck clamp confirmation	●	●	●	●	●	●	●	●	○	●	●	●	○	
	10ST	○	●	●	-	-	-	●	●	○	-	-	-	-	
	12ST	●	○	○	-	-	-	○	○	○	-	-	-	-	
	12ST_BMT75P_4,000 r/min	-	-	-	●	●	●	-	-	-	●	●	●	●	
	12ST_BMT75P_8,000 r/min	-	-	-	○	○	○	-	-	-	○	○	○	○	
	12ST(24 POSITION)_BMT75P_4,000 r/min	-	-	-	○	○	○	-	-	-	○	○	○	○	
STEADY REST*	Manual	TYPE 1 (Ø25 ~ Ø200)	○	○	○	○	○	X	X	X	X	X	X	X	X
		TYPE 2 (Ø35 ~ Ø330)	X	X	X	X	X	X	○	○	○	○	○	○	○
		TYPE 2 (Ø50 ~ Ø260)	○	○	○	○	○	○	○	○	○	○	X	X	X
		SLU-3 (Ø16 ~ Ø152)	○	○	○	○	○	○	X	X	X	X	X	X	X
		SLU-3.1 (Ø20 ~ Ø165)	○	○	○	○	○	○	X	X	X	X	X	X	X
	Hydraulic	SLU-4 (Ø30 ~ Ø245)	○	○	○	○	○	○	○	○	○	○	X	X	X
		SLU-5 (Ø45 ~ Ø310)	X	X	X	X	X	X	○	○	○	○	X	X	X
		SLU-3 (Ø16 ~ Ø152)	○	○	○	○	○	○	X	X	X	X	X	X	X
		SLU-3.1 (Ø20 ~ Ø165)	○	○	○	○	○	○	X	X	X	X	X	X	X
		SLU-4 (Ø30 ~ Ø245)	○	○	○	○	○	○	○	○	○	○	○	○	○
Prammable	SLU-5 (Ø45 ~ Ø310)	X	X	X	X	X	X	○	○	○	○	○	○	○	
	Programmable type	●	●	●	●	●	●	●	●	●	●	●	●	●	
	Live center	○	●	●	●	●	●	●	●	●	●	●	●	●	
	Built-in dead center	○	○	○	○	○	○	○	○	○	○	○	○	○	
	1.5 bar	●	●	●	●	●	●	●	●	●	●	●	X	X	
COOLANT PUMP	4.5 bar	○	○	○	○	○	○	○	○	○	○	○	○	○	
	7/10/14.5/20/70 bar	○	○	○	○	○	○	○	○	○	○	○	○	○	
	Oil skimmer	○	○	○	○	○	○	○	○	○	○	○	○	○	
COOLANT OPTIONS	Coolant chiller	○	○	○	○	○	○	○	○	○	○	○	○	○	
	Coolant pressure switch	○	○	○	○	○	○	○	○	○	○	○	○	○	
	Coolant level switch : Sensing level - Low	○	○	○	○	○	○	○	○	○	○	○	○	○	
	Coolant gun	○	○	○	○	○	○	○	○	○	○	○	○	○	
CHIP DISPOSAL	Chip conveyor (Right side)	○	○	○	○	○	○	○	○	○	○	○	○	○	
	Chip bucket	○	○	○	○	○	○	○	○	○	○	○	○	○	
	Air blower for chuck	○	○	○	○	○	○	○	○	○	○	○	○	○	
	Mist collector interface (Duct only)	○	○	○	○	○	○	○	○	○	○	○	○	○	
MEASUREMENT & AUTOMATION	Integrated mist collector	○	○	○	○	○	○	○	○	○	○	○	○	○	
	Tool setter	Manual	○	○	X	○	X	○	X	X	○	X	X	X	X
		Automatic	○	○	○	○	○	○	○	○	○	○	○	○	○
Auto door	○	○	○	○	○	○	○	○	○	○	○	○	○		
OTHERS	DN Solutions Tool load monitoring system	○	○	○	○	○	○	○	○	○	○	○	○	○	
	Signal tower	○	○	○	○	○	○	○	○	○	○	○	○	○	
	Air gun	○	○	○	○	○	○	○	○	○	○	○	○	○	
	Automatic power off	○	○	○	○	○	○	○	○	○	○	○	○	○	
	Quick change tooling(CAPTO)	○	○	○	○	○	○	○	○	○	○	○	○	○	
	Sketch-turn S/W	○	○	○	○	○	○	○	○	○	○	○	○	○	

Description	Features	PUMA 4100 series					
		A/LA/MA/LMA	B/LB/MB/LMB	C/LC/MC/LMC	XLA/XLMA	XLB/XLMB	XLC/XLMC
Customized Special Option	NON POWERED TAIL SPINDLE	○	○	○	○	○	○
	CAPTO TOOL C6	○	○	○	○	○	○
	COOLANT CHILLER	○	○	○	○	○	○
	HIGH PRESSURE COOLANT 70bar. CYCLONE FILTER THROUGH SPINDLE COOLANT	○	○	○	○	○	○
	HYD S/REST BASE/BKT_ATLING AX6 (30-255)	○	○	○	○	○	○
	HYD S/REST BASE/BKT_ATLING AX7 (45-320)	○	○	○	○	○	○
	HYD S/REST BASE/BKT_ATLING AX8 (85-360)	X	X	X	X	X	X
	PRO S/REST BASE/BKT_ATLING AX6 (30-255)	○	○	○	○	○	○
	PRO S/REST BASE/BKT_ATLING AX7 (45-320)	○	○	○	○	○	○
	PRO S/REST BASE/BKT_ATLING AX8 (85-360)	X	X	X	X	X	X
	SERVO DRIVEN S/REST	X	X	X	X	X	X
	SPIN WINDOW SYSTEM	○	○	○	○	○	○
	HOLDER INTERFACE WORK PROOF OLP40	○	○	○	○	○	○
TWIN CHUCK	X	X	X	X	X	X	

Description	Features	PUMA 5100 series														
		A/LA	B/LB	C/LC	MA/LMA	MB/LMB	XLA	XLB	XLC	XLMA	XLMB	LYA	LYB	LYC	XLYA	XLYB
Customized Special Option	NON POWERED TAIL SPINDLE	○	○	○	○	○	○	○	○	○	○	X	X	X	X	X
	CAPTO TOOL C6	○	○	○	○	○	○	○	○	○	○	X	X	X	X	X
	COOLANT CHILLER	○	○	○	○	○	○	○	○	○	○	○	○	○	○	○
	HIGH PRESSURE COOLANT 70bar. CYCLONE FILTER THROUGH SPINDLE COOLANT	○	○	○	○	○	○	○	○	○	○	○	○	○	○	○
	HYD S/REST BASE/BKT_ATLING AX6 (30-255)	X	X	X	X	X	X	X	X	X	○	X	X	X	X	X
	HYD S/REST BASE/BKT_ATLING AX7 (45-320)	○	○	○	○	○	○	○	○	○	○	X	X	X	X	X
	HYD S/REST BASE/BKT_ATLING AX8 (85-360)	○	○	○	X	X	○	○	○	X	X	X	X	X	X	X
	PRO S/REST BASE/BKT_ATLING AX6 (30-255)	○	○	○	○	○	○	○	○	○	○	X	X	X	X	X
	PRO S/REST BASE/BKT_ATLING AX7 (45-320)	X	X	X	○	○	X	X	X	○	○	X	X	X	X	X
	PRO S/REST BASE/BKT_ATLING AX8 (85-360)	○	○	○	X	X	○	○	○	X	X	X	X	X	X	X
	SERVO DRIVEN S/REST	X	X	X	X	X	○	○	○	○	○	X	X	X	○	○
	SPIN WINDOW SYSTEM	○	○	○	○	○	○	○	○	○	○	X	X	X	X	X
	HOLDER INTERFACE WORK PROOF OLP40	○	○	○	○	○	○	○	○	○	○	X	X	X	X	X
TWIN CHUCK	X	X	○	X	○	X	X	○	X	○	X	○	○	X	○	

* Please contact your DN Solutions representative for detailed machine information.

● Standard ● Optional X Not applicable

* When using a semi-synthetic type or synthetic type, contact our sales representative or service center in advance.



There is a high risk of fire when using non-water-soluble cutting fluids, processing flammable materials, neglecting the controlled and careful use of coolants and modifying the machine without the consent of the manufacturer. Always check the SAFETY GUIDELINES carefully before using the machine.

PERIPHERAL EQUIPMENT

Long boring bar OPTION

The long boring bar option allows you to easily machine deep holes to minimize cycle time. Please consult with DN Solutions specialist for details.

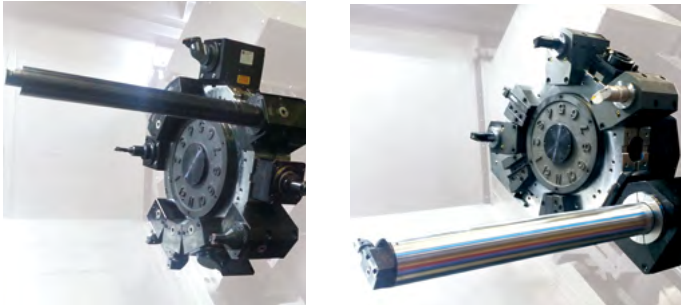

Twin chucking OPTION

For more stable pipe threading process, twin chucking option (manual or pneumatic) is available. Please consult with DN Solutions specialist for details.



Steady rest OPTION

For turning a part with extensive length, various types of hydraulic steady rests (Single, Double or Twin type) are available.

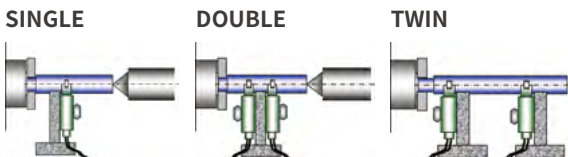
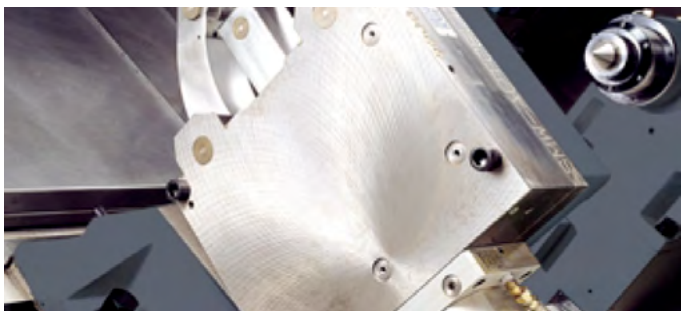

Quick change CAPTO OPTION

The quick change tool system simplifies tool change operations. Recommended for users who need to change tools frequently or to reduce set-up times.



Coolant chiller OPTION (Recommendation)

Coolant chiller is highly recommended to prevent temperature rise and minimize thermal deformation, when using a water-insoluble coolant or high-pressure coolant system of which the power is over 1.5 kw.

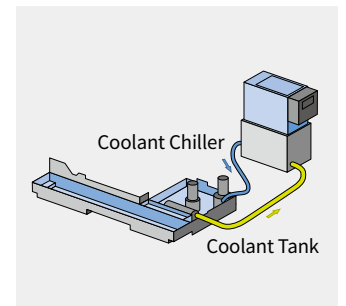

Coolant tank

DN Solutions's ergonomic roller coolant tank design, allows users to easily replace and refill coolant. Roller on the coolant tank allows users to simply take out and put it back in the machine like a drawer unit.



Chip conveyor (Right side) OPTION



Long



Short



Needle



Sludge

Hinged belt type*

Most common type of chip conveyor. Appropriate for steel materials generating chips over 30mm.

Drum filter type**

Chip conveyor with a magnet: Appropriate for machining cast iron and the generation of fine chips.

Chip conveyor type	Material	Carbon steel)			Cast iron		Aluminium		
		Long	Short	Needle	Short	Sludge	Long	Short	Needle
Hinged belt type*		○	△	X	△	X	○	△	X
Scrapper type	Normal	○	△	X	△	X	○	△	X
	Magnetic	X	○	△	○	△	X	○	△

○ : Suitable, △ : Possible, X : Not suitable

DN SOLUTIONS FANUC i PLUS

DN Solutions Fanuc i Plus maximizes customer productivity and convenience.

15" Screen + New OP

DN Solutions Fanuc i Plus' operation panel enhances operating convenience by incorporating common-design buttons and layout. It features a Qwerty keyboard for fast and easy data input and operation.

DN Solutions Fanuc i Plus

- 15-inch color display
- Intuitive and user-friendly design

USB and PCMCIA card QWERTY keyboard

- EZ-Guide i standard
- Ergonomic operator panel
- 2MB Memory
- Hot keys



iHMI touchscreen OPTION

iHMI provides an intuitive interface that uses a touchscreen for quick and easy operation.

Range of applications

Providing various applications related to planning, machining, improvement and utility, for customer convenience.

SKETCH-TURN OPTION

DN Solutions Conversational programming software for PC

- Easy to learn for beginners
- Time savings in programming
- Reduce processing cycle time



NUMERIC CONTROL SPECIFICATIONS

FANUC

Division	Item	Specifications	2-Axis	M	Y
			DN Solutions Fanuc i Plus	DN Solutions Fanuc i Plus	DN Solutions Fanuc i Plus
Controlled axis	Controlled axes		2(X,Z)	3(X,Z,C)	4(X,Z,C,Y)
	Simultaneously controlled axes		2 axes	3 axes	4 axes
Data input/output	Fast data server		○	○	○
	Memory card input/output		●	●	●
	USB memory input/output		●	●	●
	Larger capacity memory_2GB	Note *2) Available Option only with 15" Touch LCD (iHMI Only)	○ *2)	○ *2)	X
Interface function	Embedded Ethernet		●	●	●
	Fast Ethernet		○	○	○
	Enhanced Embedded Ethernet function		●	●	●
Operation	DNC operation	Included in RS232C interface.	●	●	●
	DNC operation with memory card		●	●	●
Program input	Workpiece coordinate system	G52 - G59	●	●	●
Feed function	AI contour control I	G5.1 Q_ , 40 Blocks	○	○	●
	AI contour control II	G5.1 Q_ , 200 Blocks	○	○	○
Operation Guidance Function	EZ Guidei (Conversational Programming Solution)		●	●	●
	iHMI with Machining Cycle	Note *1) Only with 15" Touch LCD standard	○ *1)	○ *1)	○ *1)
	EZ Operation package		●	●	●
Setting and display	CNC screen dual display function		●	●	●
Network	FANUC MTConnect		●	●	●
	FANUC OPC UA		●	●	●
Others	Display unit	15" color LCD	●	●	●
		15" color LCD with Touch Panel	○	○	○
	Part program storage size & Number of registerable programs	640M(256KB)_500 programs	X	X	X
		5120M(2MB)_1000 programs	●	●	●

Network: FANUC MTConnect and FANUC OPC UA available.

● Standard ○ Optional X N/A ⊕ Available

CONVENIENT OPERATION

SIEMENS S828D

15.inch display + New OP

Siemens 828D' operation panel enhances operating convenience by incorporating common-design buttons and layout. It features a Qwerty keyboard for fast and easy data input and operation.

- 15.6 inch display
- USB (standard)
- QWERTY keyboard



Convenient conversational functionality

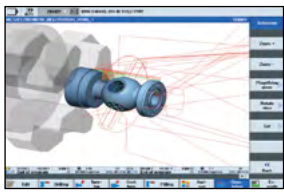

Cutting and operation support function
This function shows a cutting and tool path simulation in real-time.

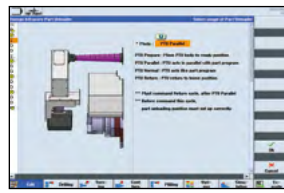

Shop-turn mode
[various]
↓
[attachments]

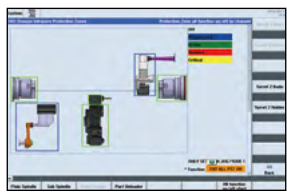

[Custom]
↓
[Protection zones]

Operation safety function

Protection Zone Synchronized Actions checks the interference between the turret and the spindle to prevent collisions caused by operator error.



[offset]
↓
[operating parameter]
↓
[TC service]

Maintenance and service convenience function

Maintenance and service of major equipment and peripheral devices, including the timer and parts counter settings can be easily undertaken.

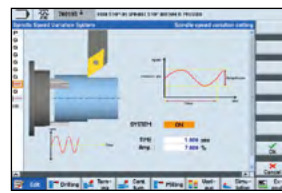

[various]
↓
[attachment]
↓
[DSSV]

Machining accuracy improvement

The NC controls spindle speed at an optimal level for precision threading and turning, making it possible to automatically improve surface roughness.

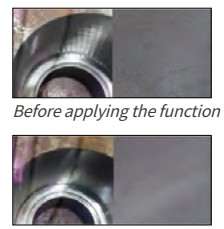

Before applying the function
After applying the function

NUMERIC CONTROL SPECIFICATIONS

SIEMENS

Division	Item	Specifications	2-Axis S828D	M S828D	S S828D	MS S828D	Y S828D	SY S828D
Controlled axis	Controlled axes		X,Z,SP	X,Z,C,R	X,Z,C,C2,B	X,Z,C,R,C2,B	X,Z,C,R,Y	X,Z,C,R,C2,Y,B
	Simultaneously controlled axes		4 axes	4 axes	4 axes	4 axes	4 axes	4 axes
Data input/output	Memory card input/output		X	X	X	X	X	X
	USB memory input/output		●	●	●	●	●	●
Interface function	Ethernet (X130)		○	○	○	○	○	○
	On network drive (without EES option, Extcall)		○	○	○	○	○	○
Operation	On USB storage medium, e.g. memory stick (without EES option, Extcall)		●	●	●	●	●	●
	Workpiece coordinate system	G54 - G59, G507 - G599	●	●	●	●	●	●
Feed function	Advanced surface		X	X	X	X	X	X
	Top surface		X	X	X	X	X	X
	Look ahead number of block		1	1	1	1	1	1
Programming & Editing function	3D simulation, finished part		●	●	●	●	●	●
	Simultaneous recording		●	●	●	●	●	●
	DXF Reader for PC integrated in SINUMERIK Operate		○	○	○	○	○	○
Operation Guidance Function	Shopturn		●	●	●	●	●	●
	EZ Operation package		●	●	●	●	●	●
Setting and display	Operation via a VNC viewer		●	●	●	●	●	●
	MTConnect OPCUA		○	○	○	○	○	○
Others	Display unit	15.6" color display with touch screen	●	●	●	●	●	●
		CNC user memory 10 MB	●	●	●	●	●	
		CNC user memory 100 MB	○	○	○	○	○	
		CNC user memory 6GB	X	X	X	X	X	
		CNC user memory 40GB (with PCU or IPC)	X	X	X	X	X	
		CNC user memory without limit (Execution from external storage devices)(EES / Using by USB or Network)	○	○	○	○	○	
		HMI user memory for CNC part program 6GB	X	X	X	X	X	

● Standard ○ Optional X N/A ☆ Available

STABLE THREADING PERFORMANCE

All PUMA 4100 / 5100 series (2-Axis* to Y-Axis) are capable of threading work.

* In order to re-machine threads or perform arbitrary speed threading on a 2-Axis machine, additional optional devices have to be selected.

Threading repair function

This function allows users to repair threads even when the original program is not available. This is a standard Fanuc NC function.

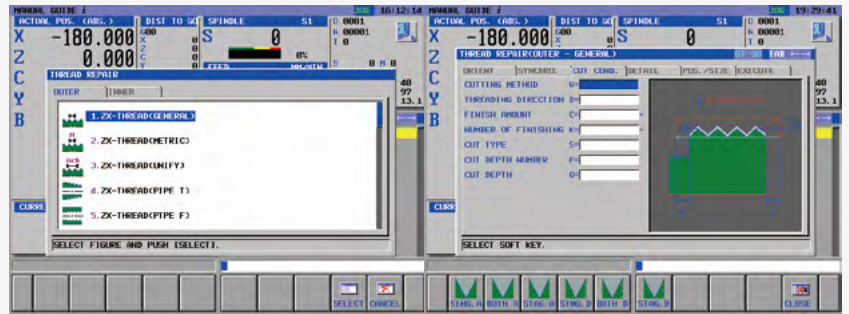

Arbitrary speed threading

OPTION

This function allows users to control and override spindle speeds in order to set them to produce/replicate the best thread quality.

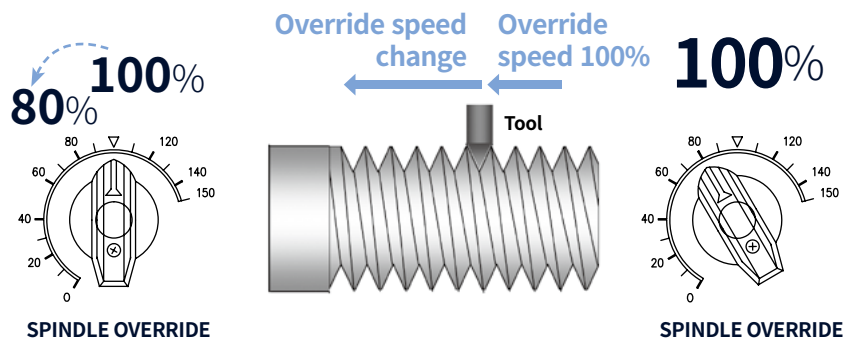

Re-machining function

This function is included in the arbitrary speed threading. It allows users to re-machine damaged threads using the existing program.

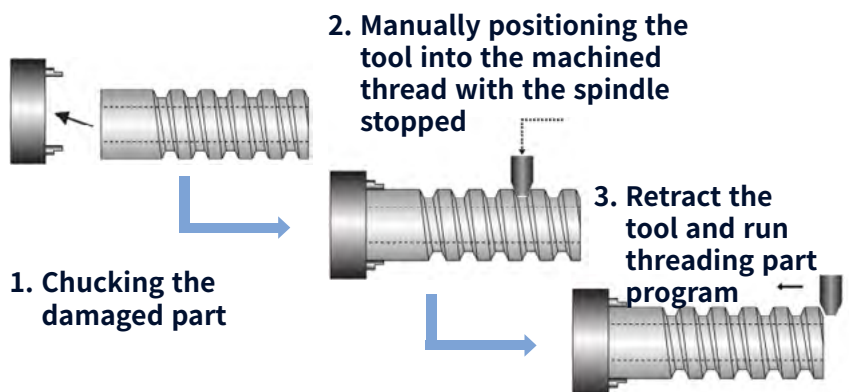

POWER | TORQUE

SIEMENS

PUMA 4100A / LA / XLA

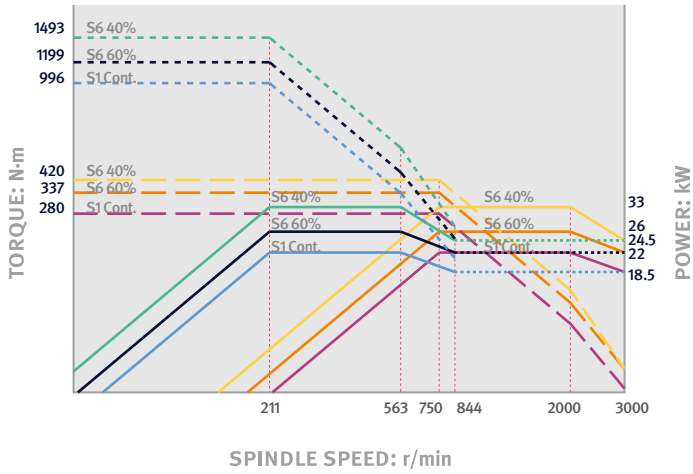

PUMA 4100B / LB / XLB

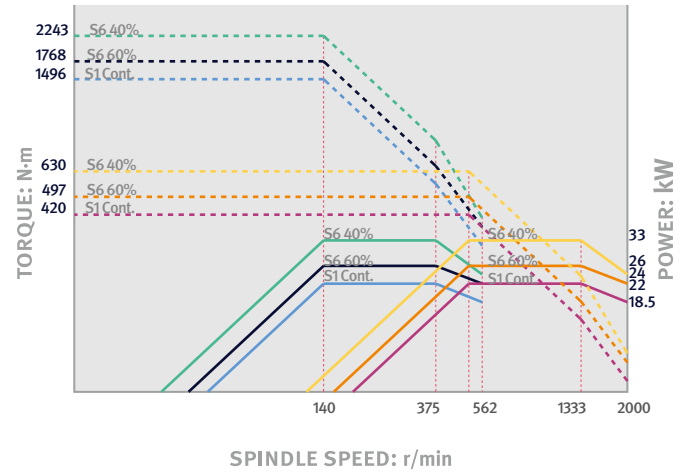

PUMA 4100C / LC / XLC

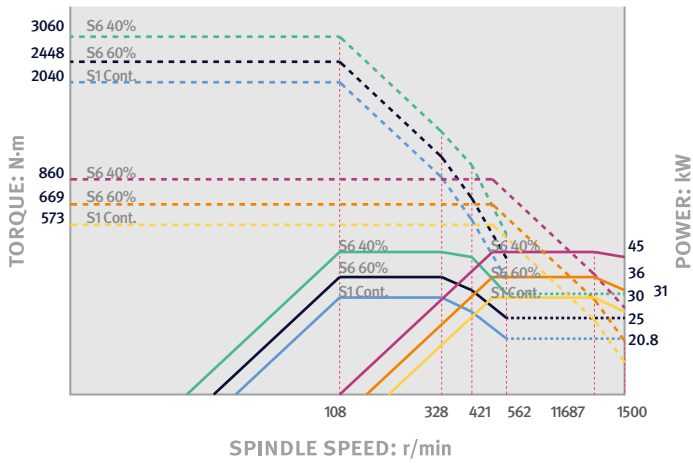

PUMA 4100MA / LMA / XLMA

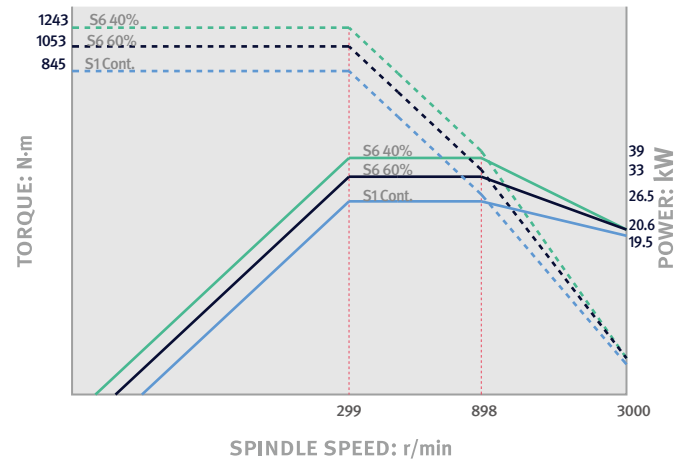

PUMA 4100MB / LMB / XLMB

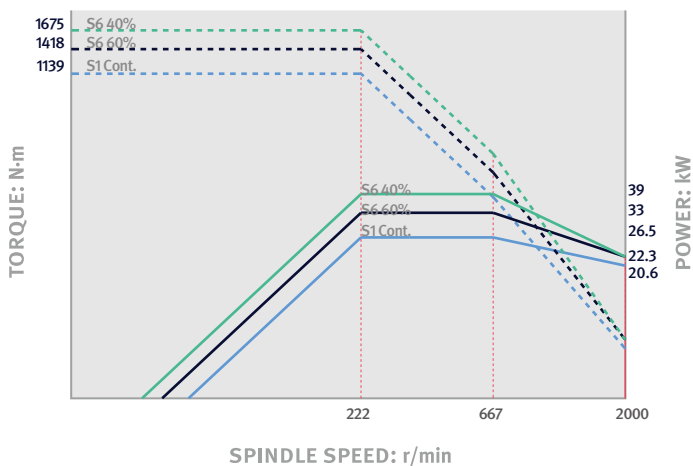

PUMA 4100MC / LMC / XLMC

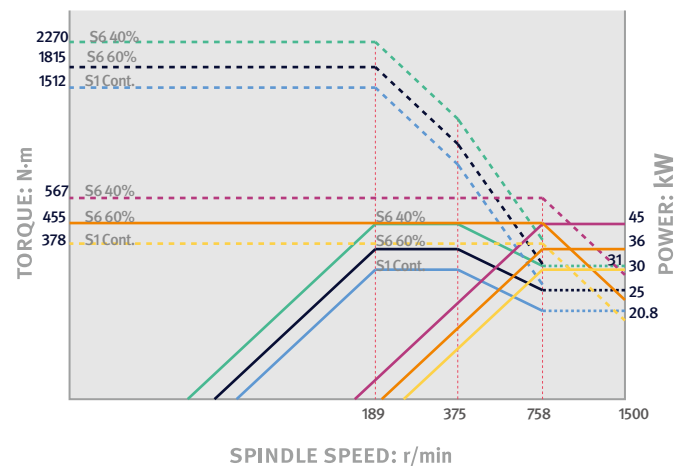

POWER | TORQUE

SIEMENS

PUMA 5100C / LC / XLC

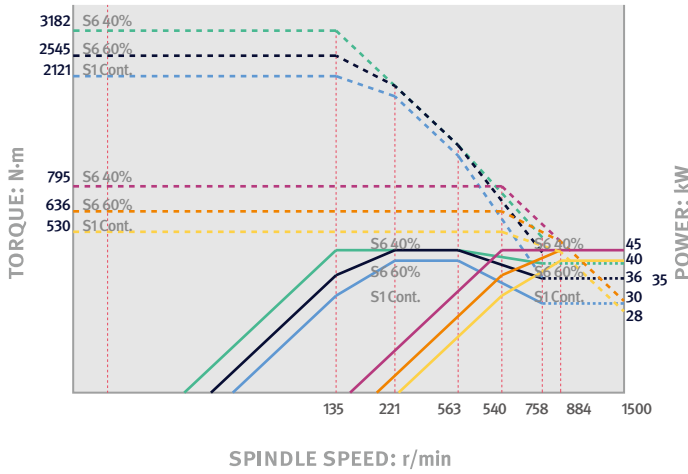

PUMA 5100MA / LMA / XLMA

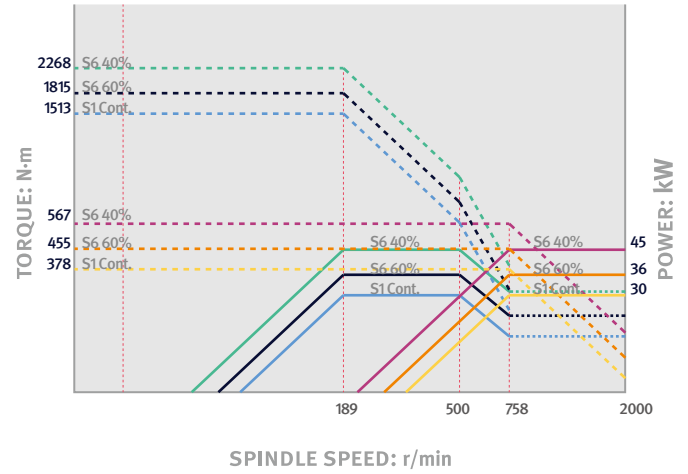

PUMA 5100MB / LMB / XLB

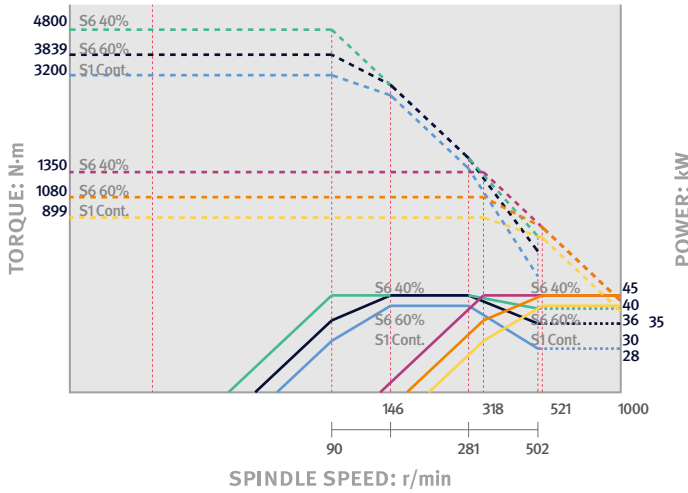

PUMA 5100LYA / XLYA

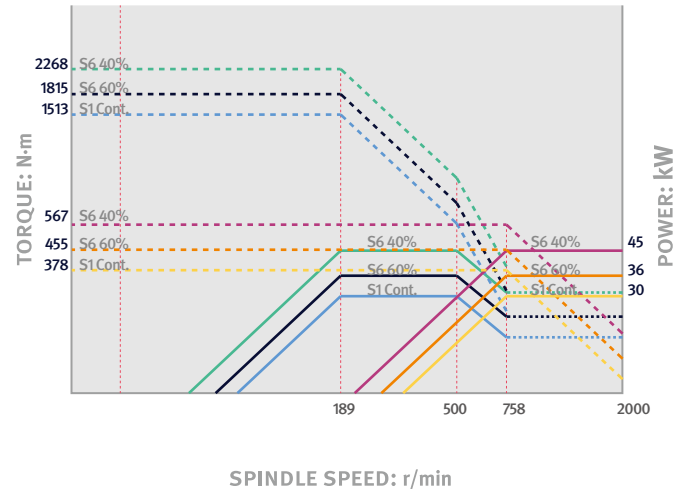

PUMA 5100LYB / XLYB

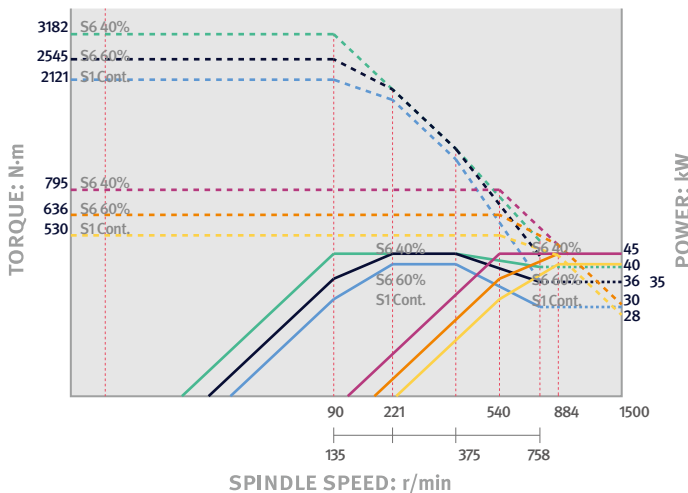

PUMA 5100LYC

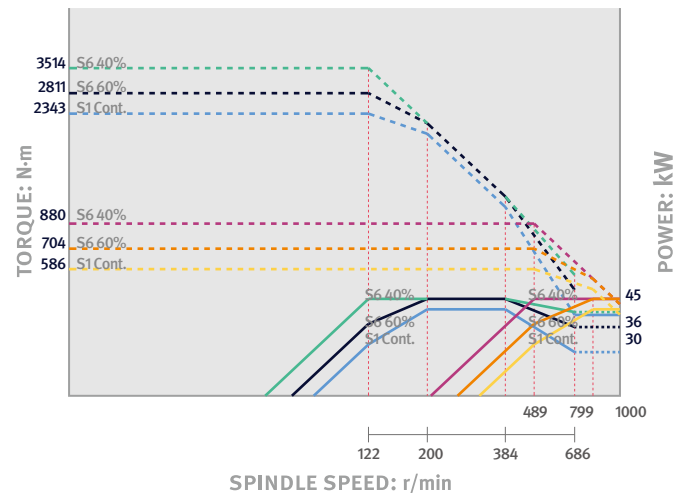

POWER | TORQUE

SIEMENS

PUMA 5100B / LB / XLB

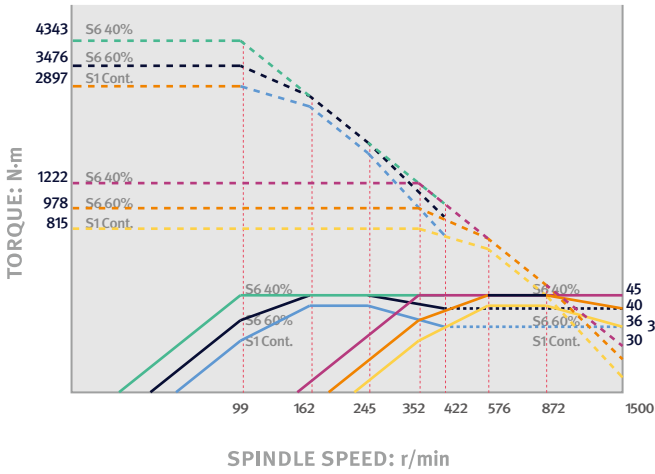

PUMA 5100A / LA / XLA

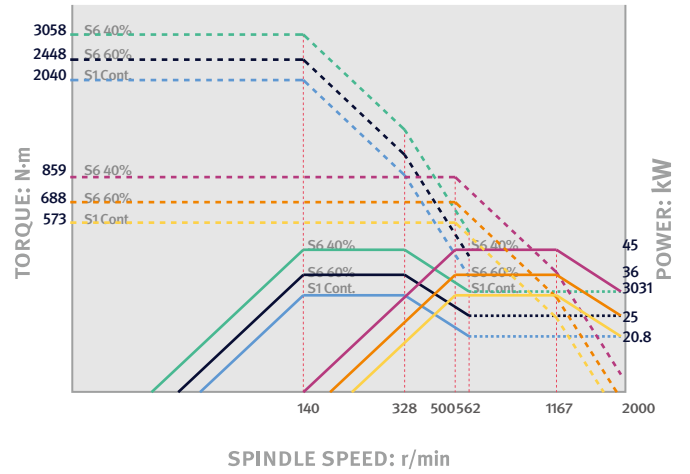

FANUC

PUMA 5100C / LC / XLC

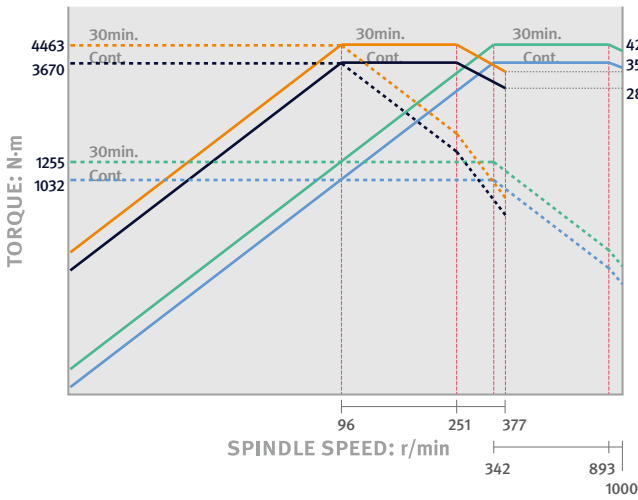

PUMA 5100MA / LMA / XLMA

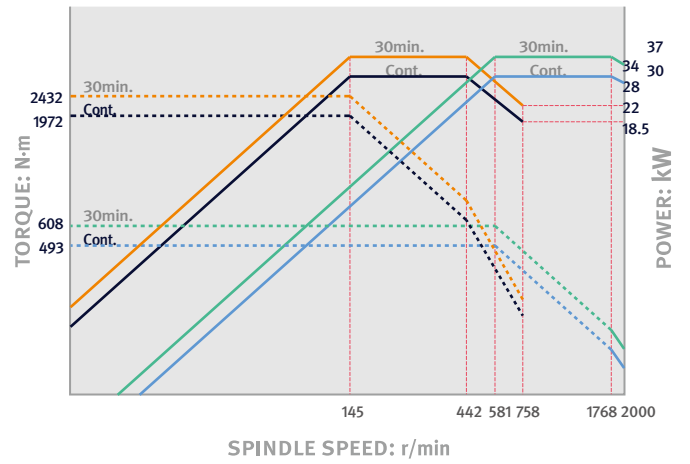

PUMA 5100MB / LMB / XLMB

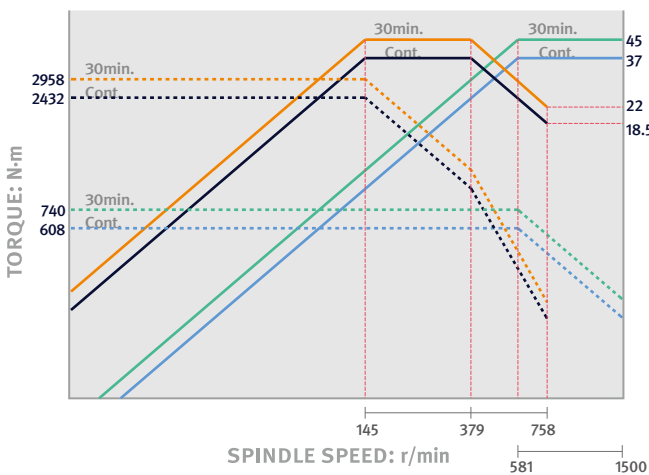

PUMA 100LYA / XLYA

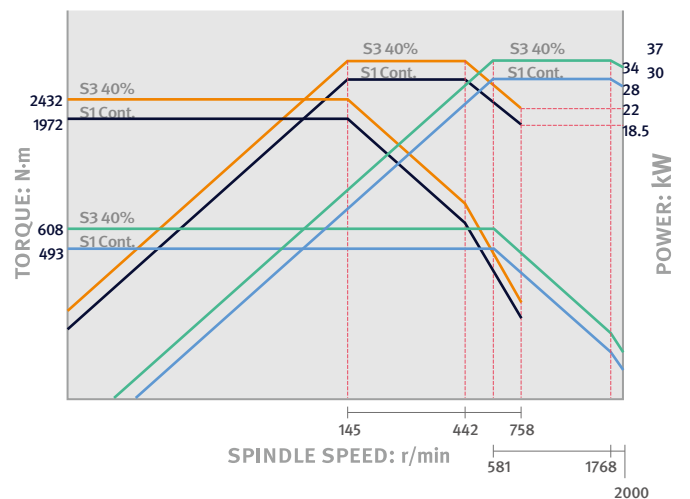

POWER | TORQUE

FANUC

PUMA 5100LYB / XLYB

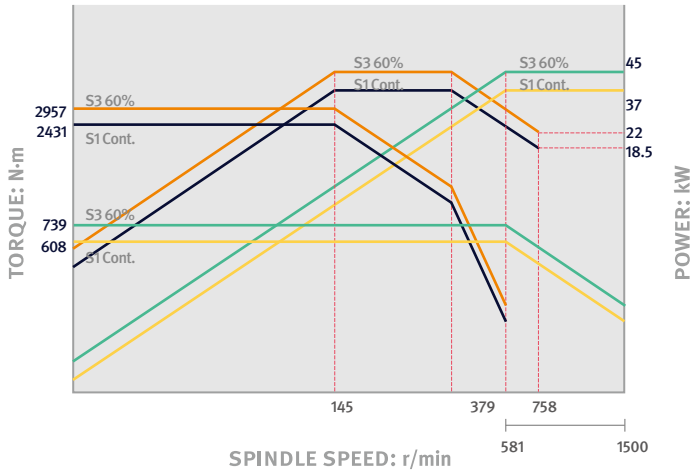

PUMA 5100LYC

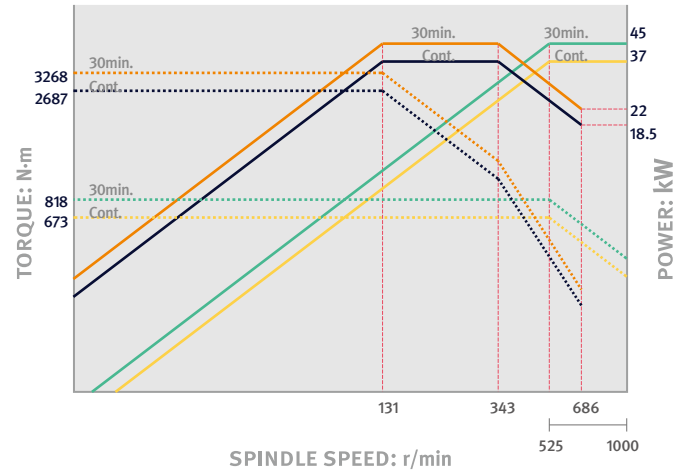

Rotary tool

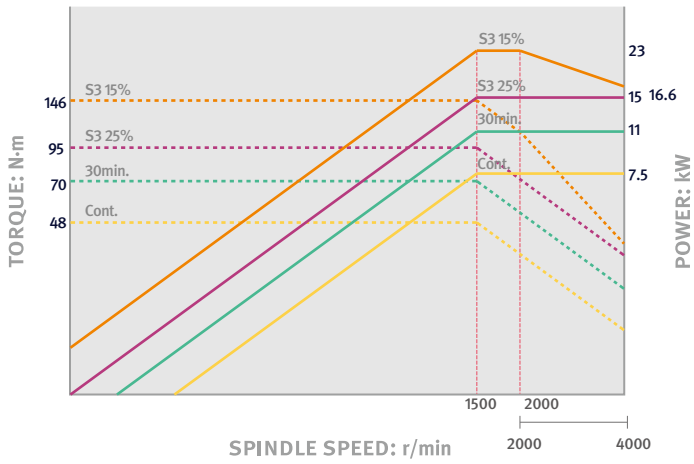

PUMA 4100A / LA / XLA

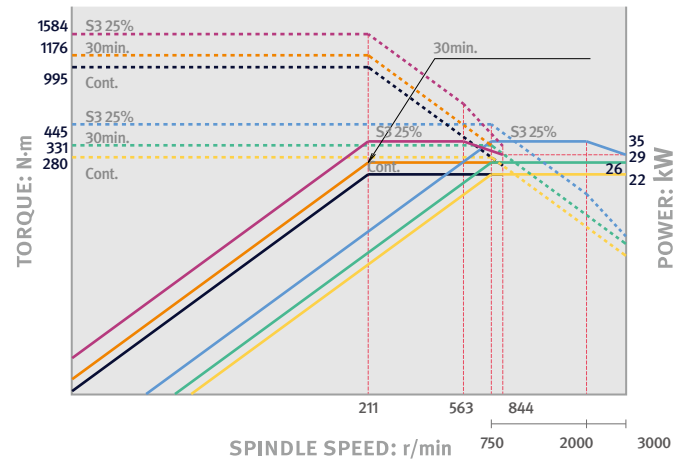

PUMA 4100B / LB / XLB

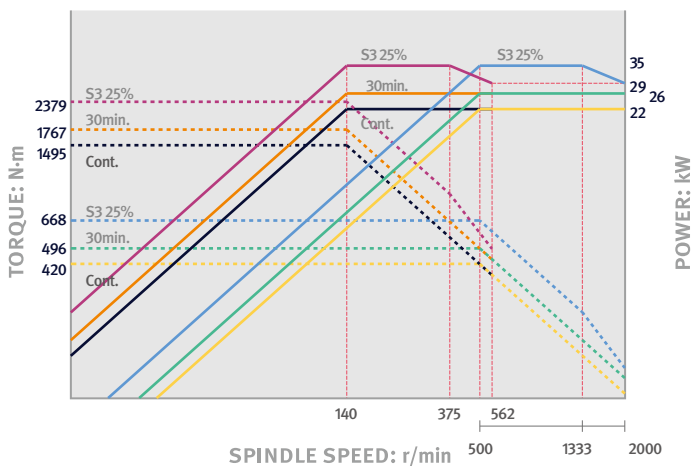

PUMA 4100C / LC / XLC

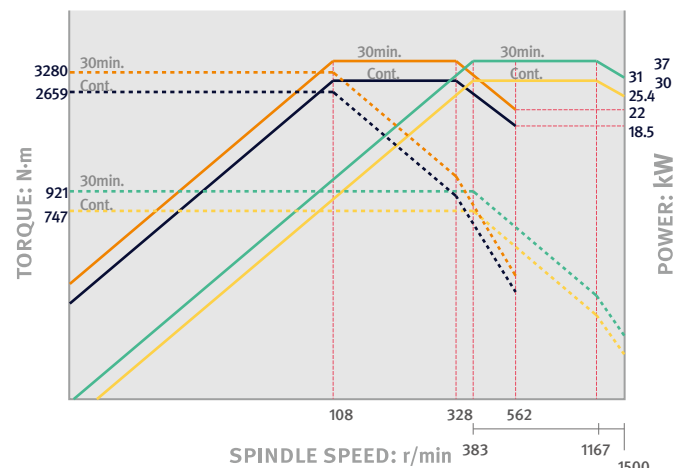

POWER | TORQUE

FANUC

PUMA 4100MA / LMA / XLMA

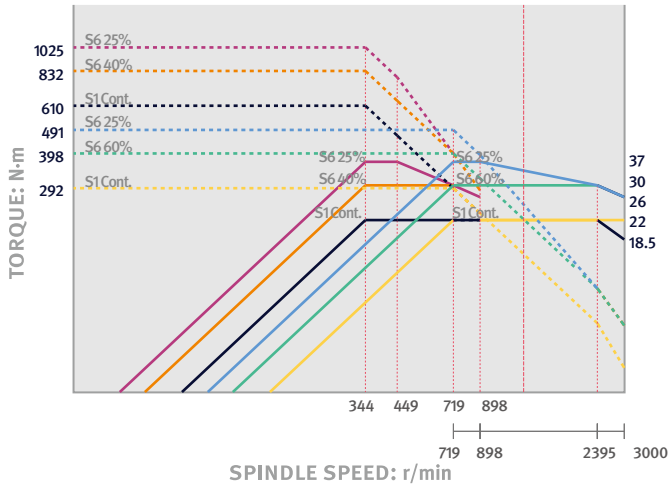

PUMA 4100MB / LMB / XLMB

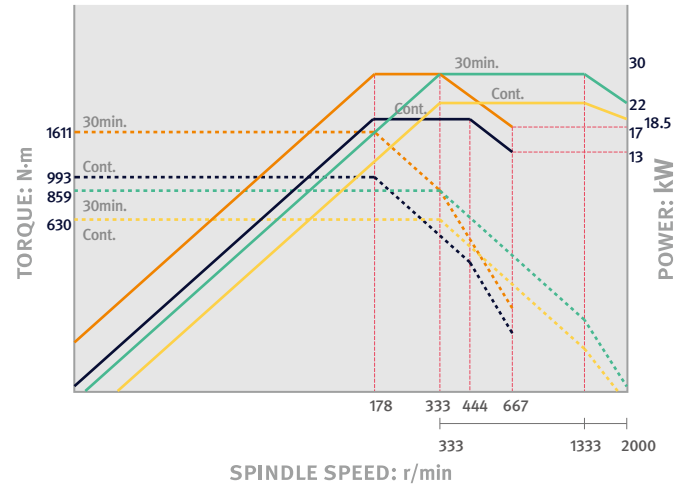

PUMA 4100MC / LMC / XLMC

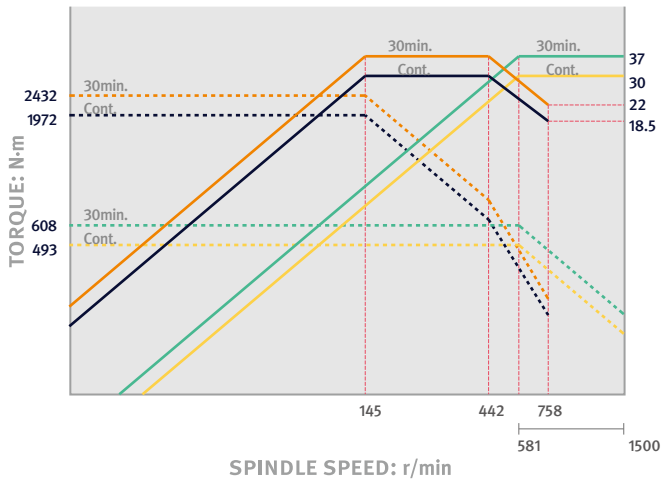

PUMA 5100A / LA / XLA

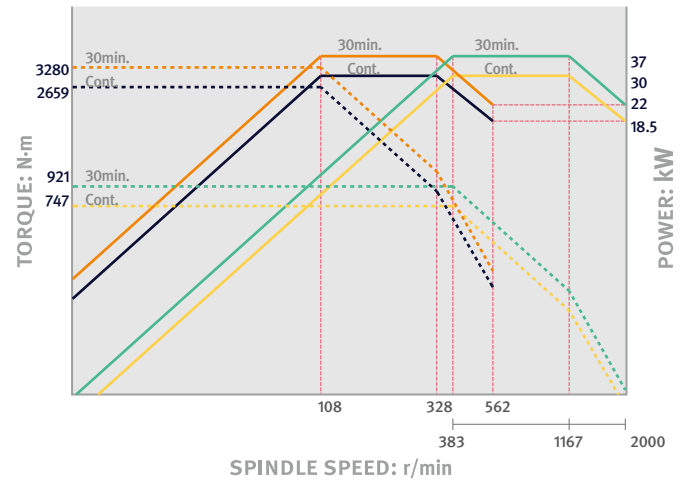

PUMA 5100B / LB / XLB

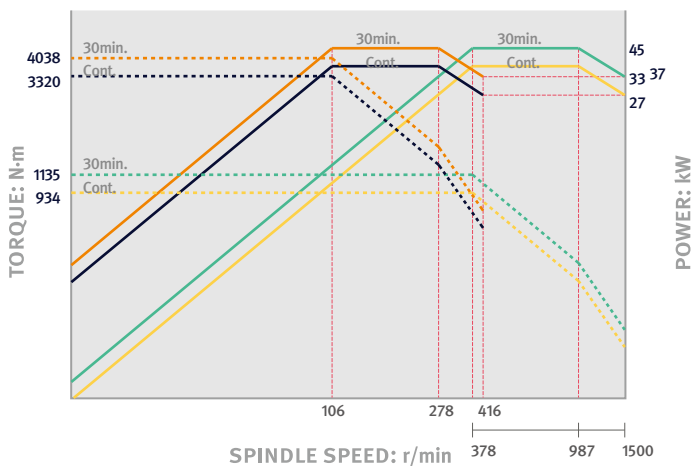

EXTERNAL DIMENSIONS

PUMA 4100 / 5100 series

Unit : mm (inch)

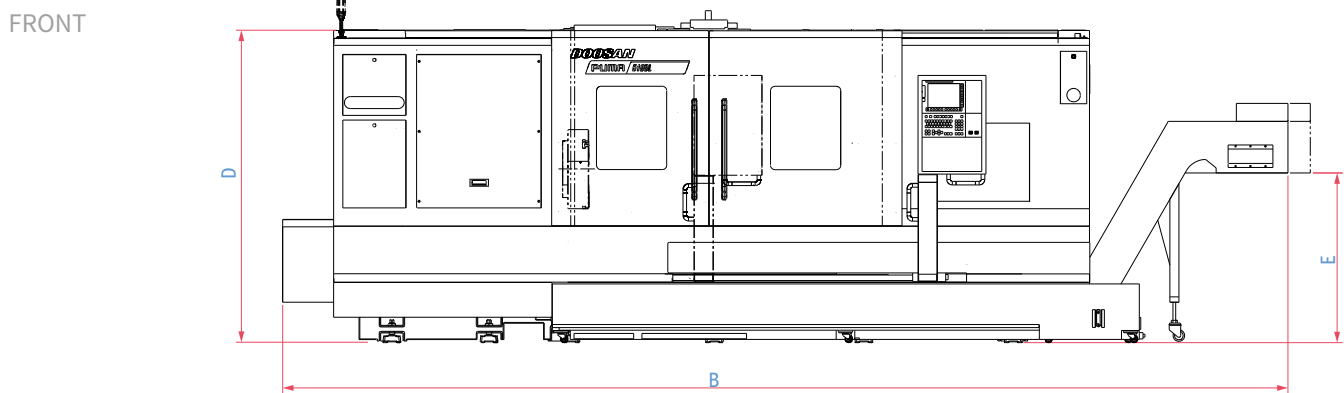
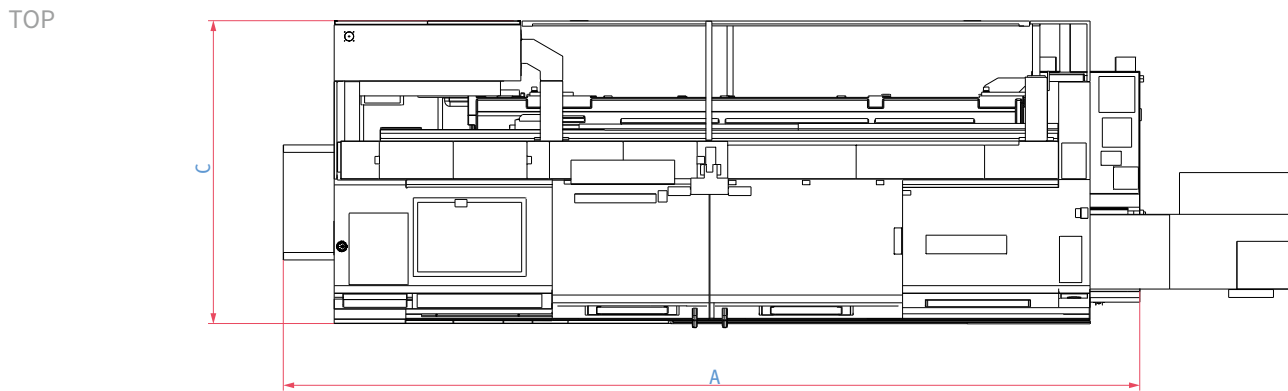

* Some peripheral equipment can be placed in other places.

Model	A (Length)	B (Length with chip conveyor)	C (Width)	D (Height)	E (Height of ground to chip outlet)
PUMA 4100 / 5100	4654 / 4759 (183.2 / 187.4)	5549 (218.5)	2056 (80.9)	2194 (86.4)	1053 (41.5)
PUMA 4100L / 5100L	5774 / 5879 (227.3 / 231.5)	6669 (262.6)	2275 (89.6)	2272 (89.4)	1053 (41.5)
PUMA 4100XL / 5100XL	7024 / 7059 (276.5 / 277.9)	7958 / 7993 (313.3 / 314.7)	2276 (89.6)	2335 (91.9)	1021 (40.2)
PUMA 4100M / 5100M	4654 / 4759 (183.2 / 187.4)	5580 (219.7)	2056 (80.9)	2194 (86.4)	1053 (41.5)
PUMA 4100LM / 5100LM	5774 / 5879 (227.3 / 231.5)	6669 (262.6)	2275 (89.6)	2272 (89.4)	1053 (41.5)
PUMA 4100XLM / 5100XLM	7024 / 7059 (276.5 / 277.9)	7958 / 7993 (313.3 / 314.7)	2276 (89.6)	2335 (91.9)	1021 (40.2)
PUMA 5100LY	5980 (235.4)	6890 (271.3)	2522 (99.3)	2885 (113.6)	1050 (41.3)
PUMA 5100XLY	7302 (287.5)	8175 (321.9)	2632 (103.6)	2937 (115.6)	1050 (41.3)

* 500 mm of a space is required to the right of the machine in order to install and remove chip conveyor.

TOOLING SYSTEM

Unit : mm (inch)

PUMA 4100

Standard

* () Supply quantity
 () 10ST
 () 12ST

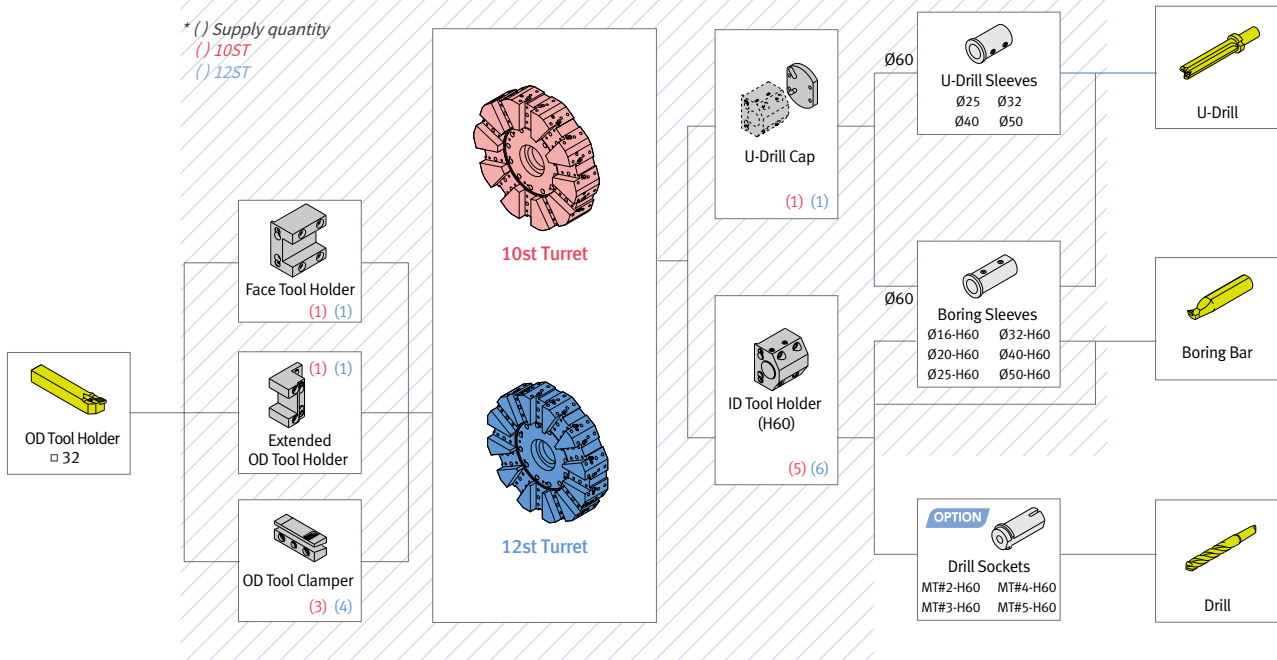

PUMA 5100

Standard

* () Supply quantity
 () 10ST
 () 12ST

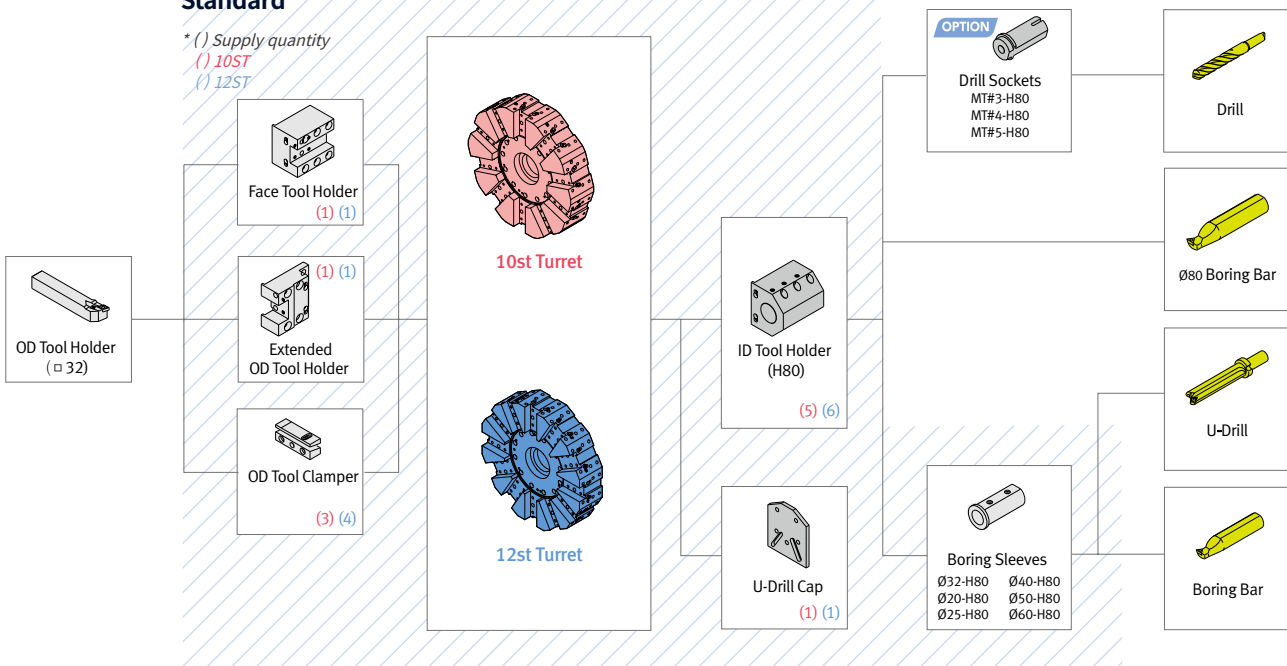

TOOLING SYSTEM | TOOL INTERFERENCE

Unit : mm (inch)

PUMA 4100M / LM / XLM, PUMA 5100M / LM / XLM / LY

Standard

* () Supply quantity

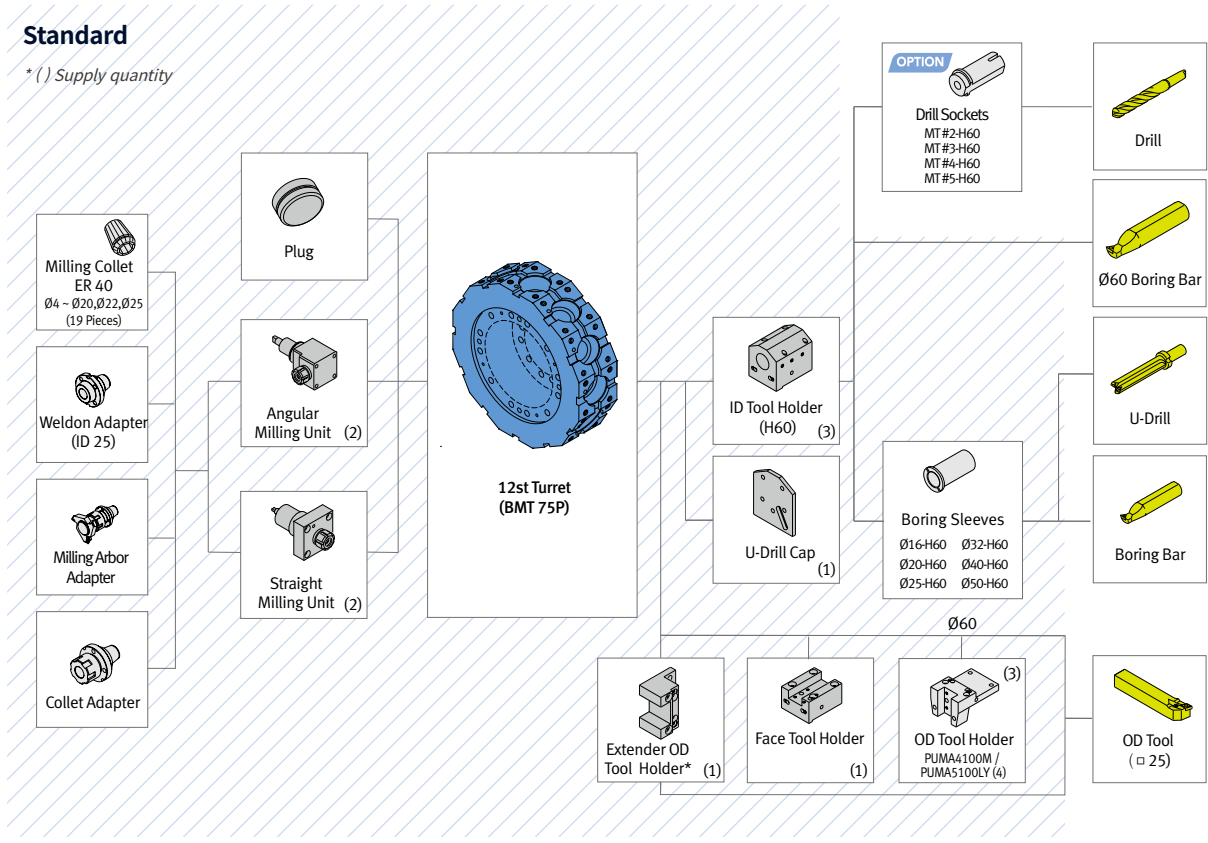

Tool interference

PUMA 4100 (10 station)

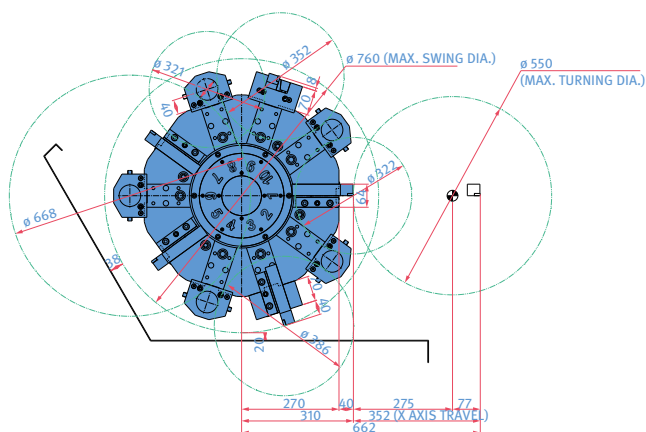

PUMA 4100 (12 station)

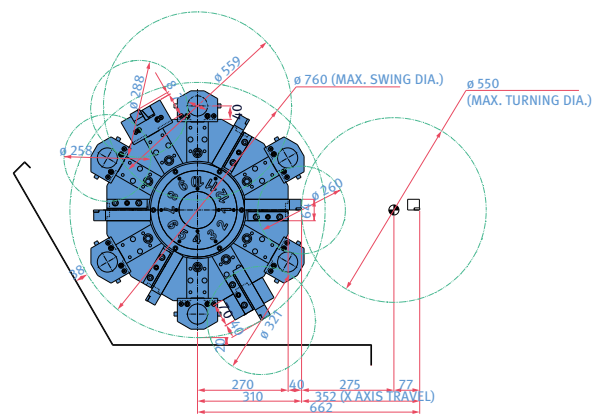

TOOL INTERFERENCE

Unit : mm (inch)

PUMA 4100M (12 station)

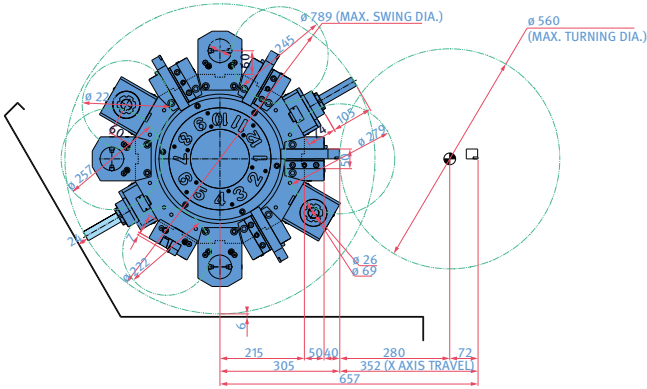

PUMA 5100 (10 station)

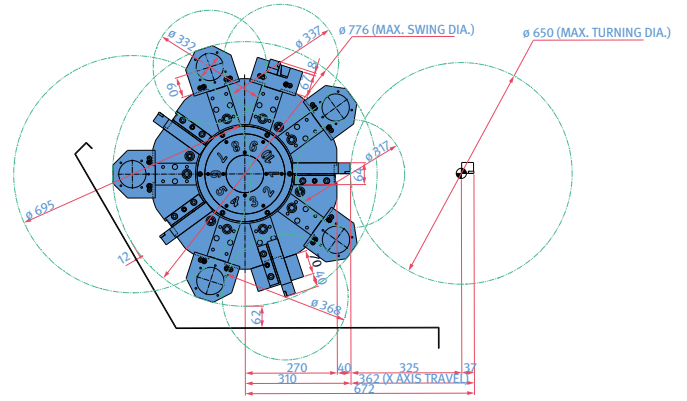

PUMA 5100 (12 station)

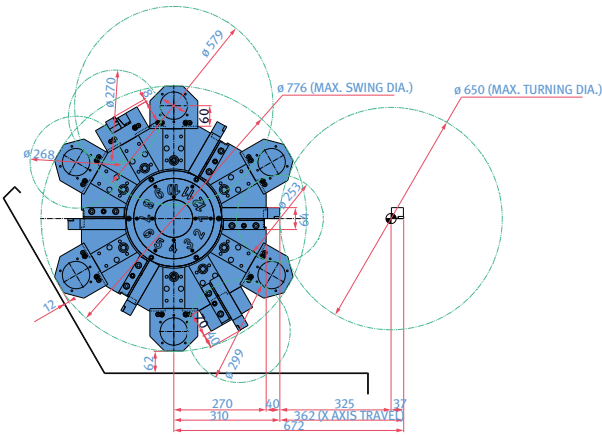

PUMA 5100M (12 station)

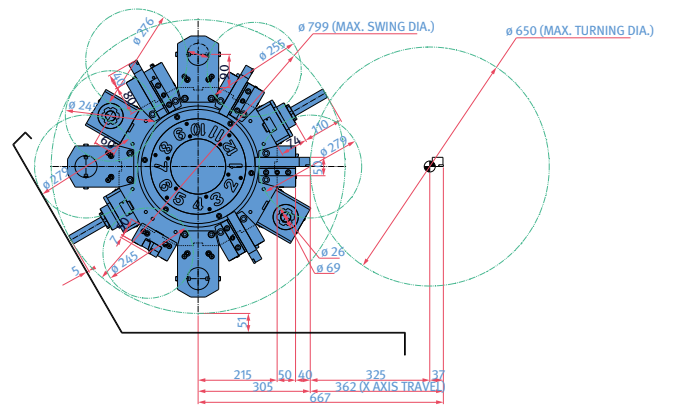

PUMA 5100LY / XLY (12 station)

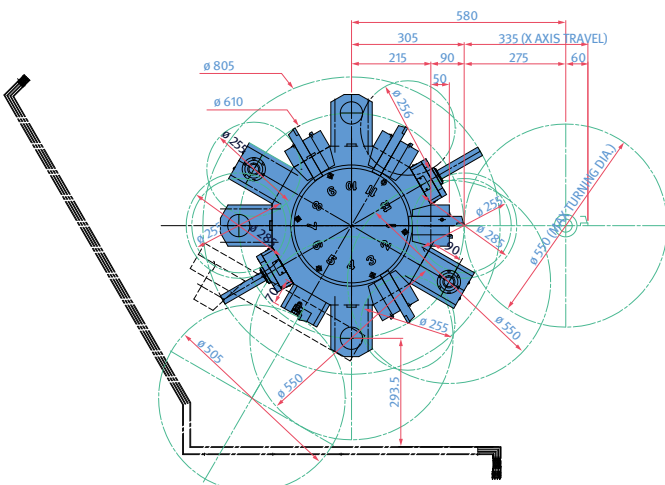

PUMA 5100LY / XLY (24 station)

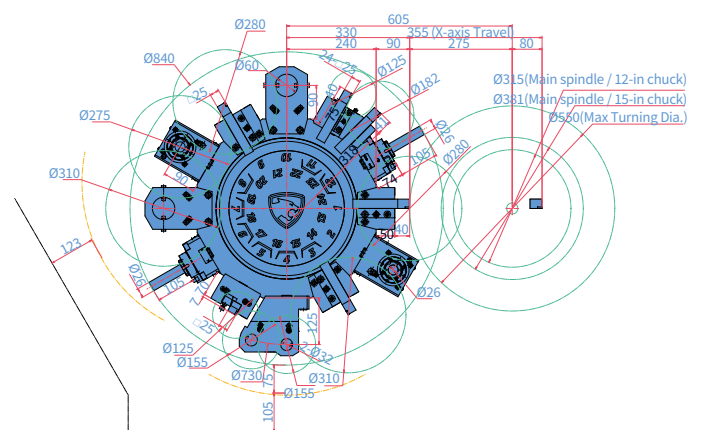

WORKING RANGE

Unit : mm (inch)

PUMA 4100 [L / XLA & XLB / XLC]

OD TOOL HOLDER

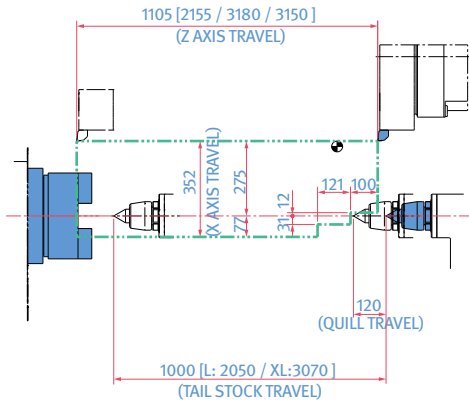

ID TOOL HOLDER

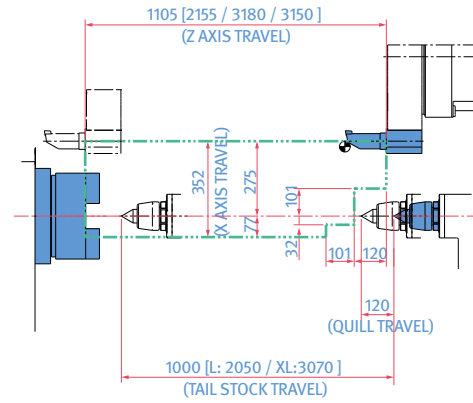

PUMA 4100M [LM / XLM]

OD TOOL HOLDER

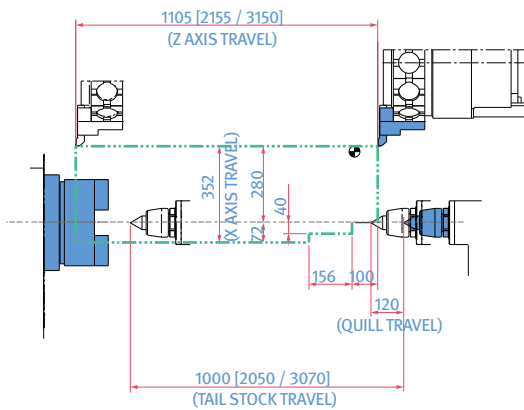

ID TOOL HOLDER Unit : mm (inch)

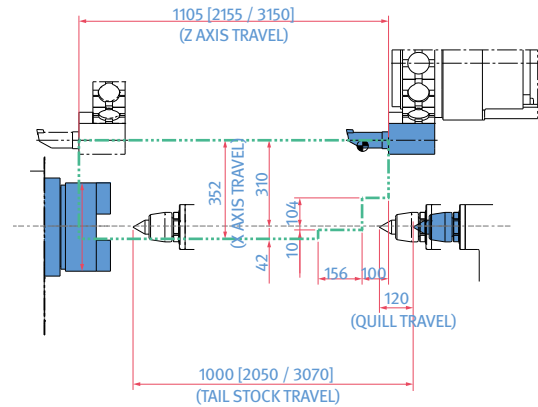

STRAIGHT MILLING UNIT

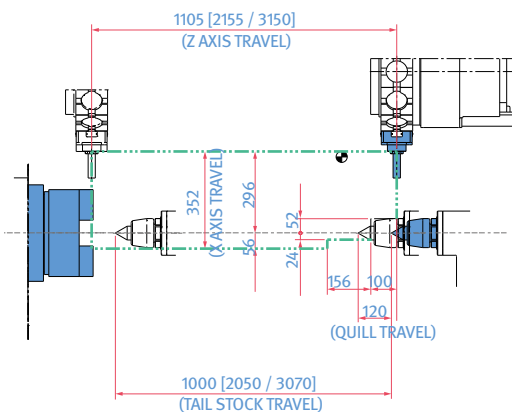

ANGULAR MILLING UNIT

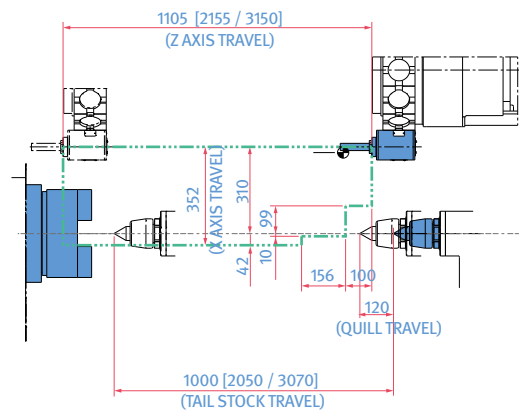

WORKING RANGE

Unit : mm (inch)

PUMA 5100 [L / XL]

OD TOOL HOLDER

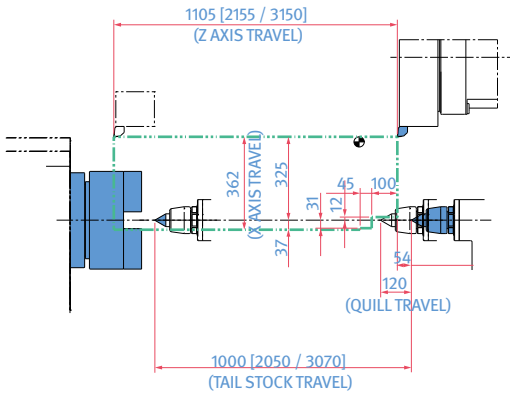

ID TOOL HOLDER

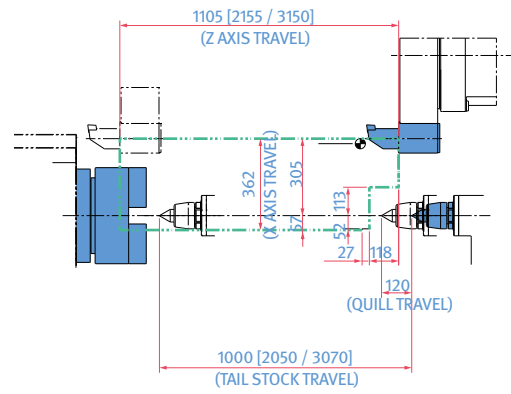

PUMA 5100M [LM / XLM]

OD TOOL HOLDER

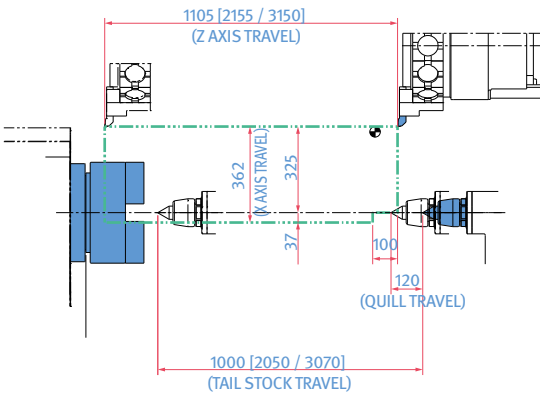

ID TOOL HOLDER

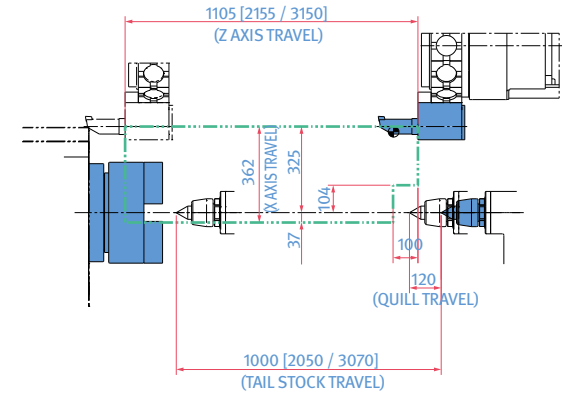

STRAIGHT MILLING UNIT

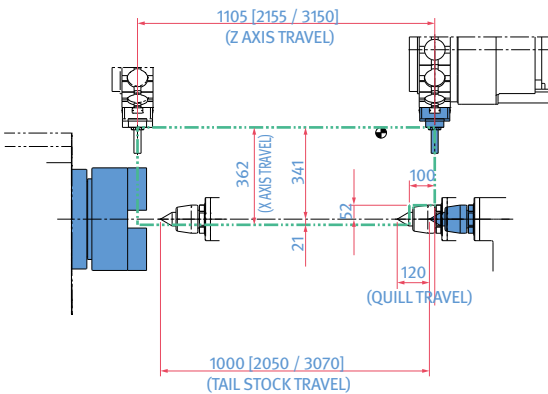

ANGULAR MILLING UNIT

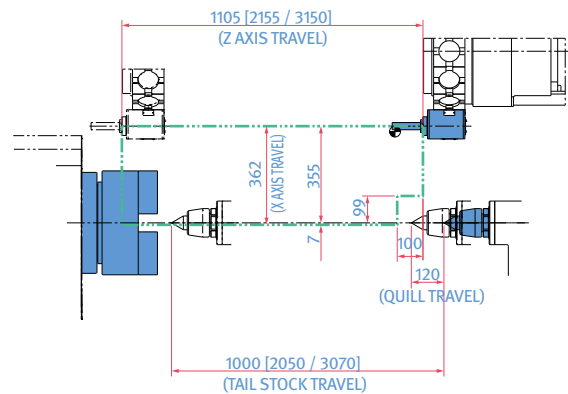

WORKING RANGE

Unit : mm (inch)

PUMA 5100LY

OD TOOL HOLDER

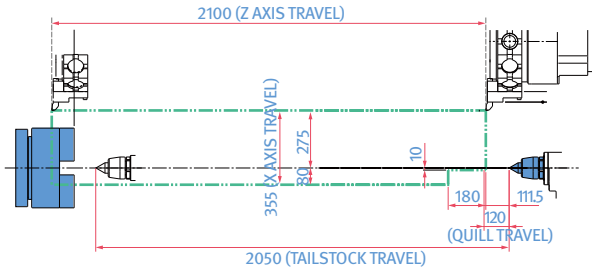

STRAIGHT MILLING UNIT

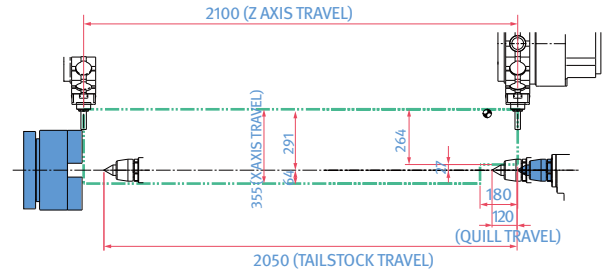

ID TOOL HOLDER

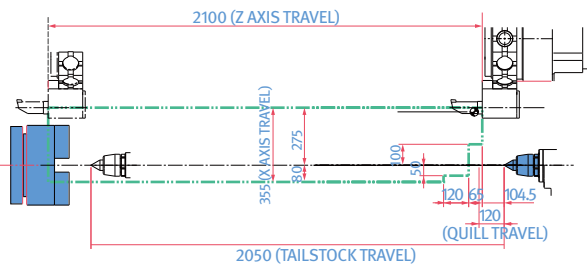

ANGULAR MILLING UNIT

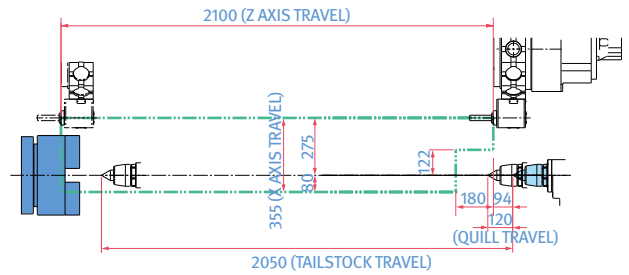

PUMA 5100XLY

OD TOOL HOLDER

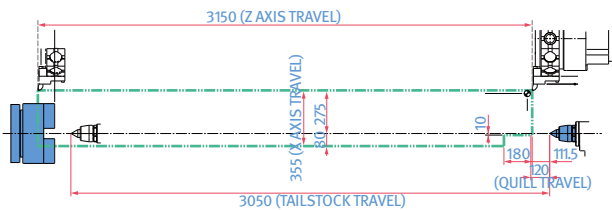

STRAIGHT MILLING UNIT

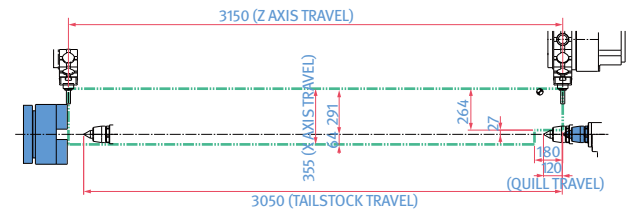

ID TOOL HOLDER

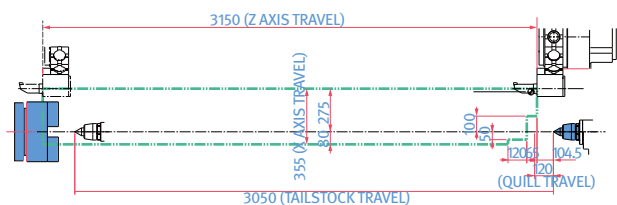

ANGULAR MILLING UNIT

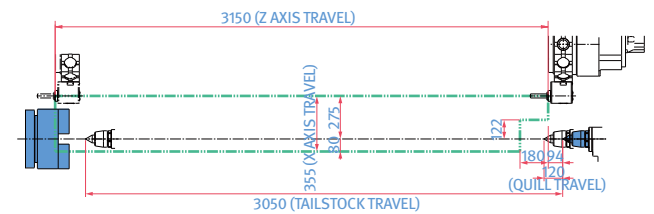

MACHINE SPECIFICATIONS

PUMA 4100 series

Description		Unit	PUMA 4100A [LA / XLA]	PUMA 4100B [LB / XLB]	PUMA 4100C [LC / XLC]	PUMA 4100MA [LMA / XLMA]	PUMA 4100MB [LMB / XLMB]	PUMA 4100MC [LMC / XLMC]	
Capacity	Swing over bed	mm (inch)	790 [790 / 770] (31.1 [31.1 / 30.3])						
	Swing over saddle	mm (inch)	590 (22.0)						
	Recom. turning diameter	mm (inch)	315 (12.4)	380 (15.0)		315 (12.4)	315 [315 / 380] (12.4 [12.4 / 15.0])		
	Max. turning diameter	mm (inch)	550 (21.7)						
	Max. turning length	mm (inch)	1074 [2124 / 3152] (42.3 [83.6 / 124.1])	1042 [2092 / 3120] (41.0 [82.4 / 122.8])	1002 [2052 / 3080] (39.4 [80.8 / 121.3])	1010 [2060 / 3100] (39.9 [81.1 / 122.0])	978 [2028 / 3068] (38.5 [79.8 / 120.8])	938 [1988 / 3028] (36.9 [78.3 / 119.2])	
	Chuck size	inch	12	15	21	12	15	21	
	Chuck work weight (including chuck)	kg (lb)	500 (1102.3)	870 (1918.0)	1400 (3086.5)	500 (1102.3)	870 (1918.0)	1400 (3086.5)	
	Shaft work weight (including chuck)	kg (lb)	1000 (2204.6)	1700 (3747.9)	2600 (5732.0)	1000 (2204.6)	1700 (3747.9)	2600 (5732.0)	
	Bar working diameter	mm (inch)	102 (4.0)	116.5 (4.6)	165.5 (6.5)	102 (4.0)	116.5 (4.6)	165.5 (6.5)	
Travels	Travel distance	X-axis	352 (13.9)						
		Z-axis	1105 [2155 / 3180] (43.5 [84.8 / 125.2])		1105 [2155 / 3150]		(43.5 [84.8 / 124.0])		
		Y-axis	-						
		C-axis	360						
	Rapid traverse rate	X-axis	16 (629.9)						
		Z-axis	20 (787.4)						
		Y-axis	-						
		C-axis	50						
Main spindle	Max. spindle speed	r/min	3000	2000	1500	3000	2000	1500	
	Main spindle motor power (30min/Cont.)	kW (Hp)	35/26/22 (46.9/34.9/29.5) (S3 25% / S3 60% / S1 Cont.)	35/26/22 (46.9/34.9/29.5) (S3 25% / S3 60% / S1 Cont.)	37/30 (49.6/40.2) (S3 60% / S1 Cont.)"	37/30/22 (49.6/40.2/29.5) (S6 25% / S6 60% / S1 Cont.)"	30/22 (40.2/29.5) (S6 60% / S1 Cont.)	-	
	Max. spindle torque	N · m (ft-lb)	1584 (1169.0)	2379 (1755.7)	3280 (2420.6)	1025 (756.4)	1611 (1188.9)	-	
	Spindle nose	ASA	A2-11		A1-15	A2-11	A2-11	A1-15	
	Spindle bearing dia.(Front)	mm (inch)	160 (6.3)	180 (7.1)	240 (9.4)	160 (6.3)	180 (7.1)	240 (9.4)	
	Max. Spindle through hole diameter	mm (inch)	115 (4.5)	132 (5.2)	181 (7.1)	115 (4.5)	132 (5.2)	181 (7.1)	
	Min. spindle indexing angle (C-axis)	deg	-				0.001		
Turret	No. of tool stations	ea	12 {10}*	10 {12}*		12 {24}, BMT75P			
	OD tool size	mm (inch)	32 x 32 (1.3 x 1.3)				Main 25*25(1.0*1.0) Sub 32*32 (1.3*1.3)		
	Max. boring bar size	mm (inch)	60 (2.4)						
	Turret indexing time (1 station swivel)	s	0.25						
	Max. rotary tool speed	r/min	-				4000 {8000}		
	Rotary tool motor power (S3 15%/S3 25%/30min/Cont.)	kW (Hp)	-				23 / 15 / 11 / 7.5 (S3 15% / S3 25% / S6 15% / S1 Cont.)		
	Max. rotary tool torque	N · m (ft-lb)	-				146 (107.7)		
Tailstock	Tailstock travel	mm(inch)	1000 [2050 / 3070] (39.4 [80.7 / 120.9])						
	Quill diameter	mm(inch)	120(4.7)						
	Quill travel	mm(inch)	120(4.7)						
	Quill bore taper	MT	MT#6 Live {MT#5 Built-in Dead}*						
Power Source	Electric power supply (rated capacity)	kVA	42.25 [43.18 / 44.98]	42.25 [43.18 / 44.98]	51.05 [51.98/53.78]	43.19 [45.06 / 44.98]	43.19 [45.06 / 44.98]	51.99 [53.86 / -]	
	Machine Dimensions	Length	4654 [5774 / 7024] (183.2 [227.3 / 276.5])						
Width		2056 [2275 / 2276] (80.9 [89.6 / 89.6])							
Height		2194 [2272 / 2335] (86.4 [89.4 / 91.9])							
Machine Dimensions	Weight	kg(lb)	9450 [10900 / 11900] (20833 [24030 / 26235])	9950 [11400 / 12400] (21936 [25132 / 27337])	10450 [11900 / 12900] (23038 [26235 / 28439])	9600 [11050 / 12050] (21164 [24361 / 26565])	10100 [11550 / 12550] (22266 [25463 / 27668])	10600 [12050 / 13050] (23369 [26565 / 28770])	
			Control	NC system	-				
			DN Solutions Fanuc i Plus, Fanuc 32i (SIEMENS 828D / 840D)**						

{ } : Option ** : Please contact DN Solutions in advance

Note1 : Standard chuck is not included in PUMA 5100C series. Depends on customers' request, its applicable chuck is different. The 't's way, some specifications are not fixed.

MACHINE SPECIFICATIONS

PUMA 5100 series

Description		Unit	PUMA 5100A [LA / XLA]	PUMA 5100B [LB / XLB]	PUMA 5100C [LC / XLC]	PUMA 5100MA [LMA / XLMA]	PUMA 5100MB [LMB / XLMB]	PUMA 5100LYA [XLYA]	PUMA 5100LYB [XLYB]	PUMA 5100LYC		
Capacity	Swing over bed	mm (inch)	900 [900 / 870] (35.4 [35.4 / 34.3])						880 (34.6)			
	Swing over saddle	mm (inch)	690 (27.2)						817 (32.2)			
	Recom. turning diameter	mm (inch)	380 (15.0)						380 (15.0)			
	Max. turning diameter	mm (inch)	650 (25.6)						550 (21.7)			
	Max. turning length	mm (inch)	1032 [2082 / 3082] (40.6 [82.0 / 121.3])	992 [2042 / 3042] (39.1 [80.4 / 119.8])		992 [2042 / 3068] (39.1 [80.4 / 120.8])	952 [2002 / 3028] (37.4 [78.8 / 119.2])	2050 (80.7) [3070 (120.9)]	2020 (79.5) [3040 (119.7)]			
	Chuck size	inch	15	21	No chuck (order base)		15	21	15	21	No chuck (order base)	
	Chuck work weight (including chuck)	kg (lb)	870 (1918.0)	1400 (3086.5)	2000 (4409.2)		870 (1918.0)	1400 (3086.5)	870 (1918.0)	1400 (3086.5)	2000 (4409.2)	
	Shaft work weight (including chuck)	kg (lb)	1700 (3747.9)	2600 (5732.0)	3600 (7936.6)		1700 (3747.9)	2600 (5732.0)	1700 (3747.9)	2600 (5732.0)	3600 (7936.6)	
Bar working diameter	mm (inch)	116.5 (4.6)	165.5 (6.5)	depends on applied chuck		116.5 (4.6)	165.5 (6.5)	116.5 (4.6)	165.5 (6.5)	depends on applied chuck		
Travels	Travel distance	X-axis	362 (14.3)						355 (14.0)			
		Z-axis	1105 [2155 / 3150] (43.5 [84.8 / 124.0])						2100 (82.7) [3150 (124.0)]			
		Y-axis	-						150 (5.9)			
		C-axis	-						360			
	Rapid traverse rate	X-axis	16 (629.9)						20 (787.4)			
		Z-axis	20 (787.4)						18 (708.7) [20 (787.4)]			
		Y-axis	-						10 (393.7)			
		C-axis	-						50 [100]			
Main spindle	Max. spindle speed	r/min	2000	1500	1000		2000	1500	2000	1000		
	Main spindle motor power (30min/Cont.)	kW (Hp)	37/30 (49.6/40.2) (S3 60% / S1 Cont.)	45/37 (60.3/49.6) (S3 60% / S1 Cont.)	45/37 (60.3/49.6) (S3 60% / S1 Cont.)		37/30 (49.6/40.2) (S3 60% / S1 Cont.)	45/37 (60.3/49.6) (S3 60% / S1 Cont.)	37/30 (49.6/40.2) (S3 60% / S1 Cont.)	45/37 (60.3/49.6) (S3 60% / S1 Cont.)		
	Max. spindle torque	N·m (ft-lb)	3280 (2420.6)	4038 (2980.0)	4463 (3293.7)		2432 (1794.8)	2957 (2182.3)	2431 (1794.1)	2957 (2182.3)		
	Spindle nose	ASA	A2-11	A1-15	ISO 702-4 NO.20		A2-11	A1-15	A2-11	A1-15		
	Spindle bearing dia. (Front)	mm (inch)	180 (7.1)	240 (9.4)	340 (13.4)		180 (7.1)	240 (9.4)	180 (7.1)	240 (9.4)		
	Max. Spindle through hole diameter	mm (inch)	132 (5.2)	181 (7.1)	275 (10.8)		132 (5.2)	181 (7.1)	132 (5.2)	181 (7.1)		
	Min. spindle indexing angle (C-axis)	deg	-				0.001		0.001			
Turret	No. of tool stations	ea	10 {12}*			12 {24}, BMT75P		12 {24}, BMT75P				
	OD tool size	mm (inch)	32 x 32 (1.3 x 1.3)			25 x 25 {32 x 32} (1.0 x 1.0 {1.3 x 1.3})*		25 x 25 {32 x 32} (1.0 x 1.0 {1.3 x 1.3})*				
	Max. boring bar size	mm (inch)	80 (3.1)			60 (2.4)		60 (2.4)				
	Turret indexing time (1 station swivel)	s	-			0.25		0.25				
	Max. rotary tool speed	r/min	-			4000{8000}		4000{8000}				
	Rotary tool motor power (S3 15%/S3 25%/30min/Cont.)	kW (Hp)	-			23/15/11/7.5 (30.8/20.1/14.8/10.1)		23/15/11/7.5 (30.8/20.1/14.8/10.1)				
	Max. rotary tool torque	N·m (ft-lb)	-			146 (107.7)		146 (107.7)				
Tailstock	Tailstock travel	mm (inch)	1000 [2050 / 3070] (39.4 [80.7 / 120.9])						2050 (80.7)			
	Quill diameter	mm (inch)	120 (4.7)						120 (4.7)			
	Quill travel	mm (inch)	120 (4.7)						120 (4.7)			
	Quill bore taper	MT	MT#6 Live {MT#5 Built-in Dead}*						MT#6 Live {MT#5 Built-in Dead}*			
Power Source	Electric power supply (rated capacity)	kVA	52.55 [52.55 / 53.78]	60.25 [60.25 / 59.36]	60.25 [60.25 / 59.36]		53.86 [53.86 / 53.78]	61.56 [61.56 / 59.36]	61.09	68.79	68.79	
			Machine Dimensions	Length	4759 [5879 / 7059] (187.4 [231.5 / 277.9])						5980 (235.4) [7302 (287.5)]	
				Width	2056 [2275 / 2276] (80.9 [89.6 / 89.6])						2522 (99.3) [2632 (103.6)]	
Machine Dimensions	Height	2194 [2272 / 2335] (86.4 [89.4 / 91.9])						2885 (113.6) [2937 (115.6)]				
	Weight	kg (lb)	10100 [11550 / 12550] (22266 [25463 / 27668])	10600 [12050 / 13050] (23369 [26565 / 28770])	10650 [12100 / 13100] (23479 [26676 / 28880])	10250 [11700 / 12700] (22597 [25794 / 27998])	10750 [12200 / 13200] (23699 [26896 / 29101])	13000 (28660) [16000 (35273)]				
Control	NC system	-										
DN Solutions Fanuc i Plus, Fanuc 32i (SIEMENS 828D / 840D)**												

Note 1 : Standard chuck is not included in PUMA 5100C series. Depends on customers' request, its applicable chuck is different. The t's way, some specifications are not fixed. *{ } : Option ** : Please contact DN Solutions in advance

The DN Solutions promise, MACHINE GREATNESS, has two important meanings. The first is simple: DN Solutions makes great machines. The second is a challenge to our end-users. With a product line that is this comprehensive, accurate and reliable, we equip our customers to machine greatness. The big question: ***Why should you choose DN Solutions over other options?***

Here's why...



**MACHINE
GREATNESS™**



WHAT YOU MAKE AND HOW YOU MAKE IT MATTERS—SO MAKE IT GREAT WITH DN SOLUTIONS.

UNBEATABLE MACHINES

You won't find a more comprehensive range or a better combination of value, performance and reliability anywhere else.

ROBUST PRODUCT LINE

We offer an impressive range of machine models and hundreds of configurations. Whatever your machining needs and requirements, there's a DN Solutions for you.

READILY AVAILABLE - ANYWHERE IN THE WORLD

Machining centres (including 5-axis machines), lathes, multi-tasking turning centres and mill-turn machines, and horizontal borers with best-in-class specifications are all available...ready to install.

EXPERT SERVICE

Our dedicated, experienced and knowledgeable team is totally committed to improving your productivity, growth and success.

RESPONDING TO CUSTOMERS ANYTIME, ANYWHERE

DN Solutions Global Network

DN Solutions provides systems-based professional support services, before and after the machine tool sale, by responding quickly and efficiently to customers. By supplying spare parts, product training, field service and technical support, we provide the expert care, attention and assistance our customers expect from a market leader.

Global sales and service support network		51	Technical centers Technical center, Sales support, Service support, Parts support
4	Corporations	200	Service posts
155	Dealer networks	3	Factories



CUSTOMER SUPPORT AND SERVICES

We're there for you whenever you need us.

We help our customers operate at maximum efficiency by providing them with a range of tried, tested and trusted services - from pre-sales consultancy to post-sales support.



Field services

- On-site service
- Machine installation and testing
- Scheduled preventive maintenance
- Machine repair service



Parts supply

- Supplying a wide range of original DN Solutions spare parts
- Parts repair service



Training

- Programming, machine setup and operation
- Electrical and mechanical maintenance
- Applications engineering



Technical support

- Supports machining methods and technology
- Responds to technical queries
- Provides technical consultancy



dn-solutions.com

Head Office

22F T Tower, 30, Sowol-ro 2-gil
Jung-gu, Seoul, Korea, 04637

Tel: +82-2-6972-0370/0350
Fax: +82-2-6972-0400

DN Solutions America

19A Chapin Road, Pine Brook
New Jersey 07058, United States

Tel: +1-973-618-2500
Fax: +1-973-618-2501

DN Solutions Europe

Emdener Strasse 24, D-41540
Dormagen, Germany

Tel: +49-2133-5067-100
Fax: +49-2133-5067-111

DN Solutions India

No.82, Jakkuar Village
Yelahanka Hobli, Bangalore-560064

Tel: + 91-80-2205-6900
E-mail: india@dncompany.com

DN Solutions China

Room 101,201,301, Building 39 Xinzhuan
Highway No.258 Songjiang District
China Shanghai (201612)

Tel: +86 21-5445-1155
Fax: +86 21-6405-1472

Sales inquiry

sales@dncompany.com

* For more details, please contact DN Solutions.

* Specifications and information contained within this catalogue may be changed without prior notice.